

Singer 96-45

FORM 18957
(196)
PRINTED IN U. S. A.

LIST OF PARTS



MACHINE No. 96-45

THE SINGER MANUFACTURING COMPANY

From the library of: Diamond Needle Corp

INSTRUCTIONS FOR OILING

Oil should be applied at the places indicated by the word "OIL" and when the machine is in continuous use it should be oiled at least four times each day. All wicking must be kept saturated with oil.

Use Only Singer "Manufacturing Sewing Machine Oil (Cloth and Leather)" for general use or "Manufacturing Sewing Machine Oil (Stainless for White Goods)" where a stainless oil is desired.

Copyright, U. S. A., 1921, 1928, 1933, 1935 and 1936
by The Singer Manufacturing Co.
All Rights Reserved for all Countries

INDEX

	Page
Accessories.....	14
Bobbin Winders.....	14
Finger Guard.....	17
Foot Lifter Parts.....	17
Knee Lifter Parts.....	18
Knife Grinder.....	19
Machine Base.....	14
Machine No. 96-45.....	5
Numerical List of Parts.....	23
Thread Unwinder.....	20
Wrenches.....	21

INSTRUCTIONS FOR ORDERING

In ordering from this list, use ONLY the part NUMBER in the FIRST column.

The number stamped on a Sewing Machine Part is in every case the number of the single part only.

Every combination of parts sent out as such has its specific number, which, although not stamped on the parts, must be used when ordering the combination.

Each number always indicates the SAME PART in whatever list it appears, or for whatever machine.

The letters after some of the numbers indicate the style of finish only, as follows:

- A-Hardened, Polished, Nickel Plated and Buffed
- B-Polished, Nickel Plated and Buffed
- C-Hardened Only
- D-Polished Only
- E-Soft, Not Polished
- F-Hardened and Polished
- G-Bright Rumbled and Nickel Plated
- H-Blued
- J-Nickel Plated Only
- K-Hardened and Nickel Plated
- L-Brass Plated
- M-Oxidized
- N-Japanned, Dull
- P-Japanned, Bright
- R-Merlized
- T-Copper Plated
- T.A-Hardened, Polished, Copper and Nickel Plated and Buffed
- T.B-Copper and Nickel Plated and Polished
- T.J-Copper and Nickel Plated Only
- T.K-Hardened, Copper and Nickel Plated
- T.M-Copper Plated and Oxidized
- T.L-Copper and Brass Plated
- U-Zinc Plated
- V-Silver Plated
- W-Polished and Nickel Plated
- Y-Black Nickel Plated Only
- Z-Chromium Plated
- Z.B-Polished, Nickel Plated, Buffed and Chromium Plated
- Z.J-Nickel and Chromium Plated

These letters MUST BE USED when they appear in the list; and AFTER the number as in the list.

In this series:
 1 to 1500, 50001 to 51500 and 140001 to 142000 are Screw Numbers
 1501 to 1600 and 51501 to 51800 are Nut Numbers
 1801 to 2000 and 51801 to 52000 are Roller Numbers
 2001 to 50000 and 52001 to 140000 and 142001 to 190000 are Sewing Machine Parts, 190001 and upward are numbers of Electrical Parts.

The figures in the second column refer only to the plates, illustrating the parts, and are NOT TO BE USED in ordering.
 Parts marked with an asterisk (*) are furnished only when repairs are made at factory.

LIST OF PARTS COMPLETE FOR

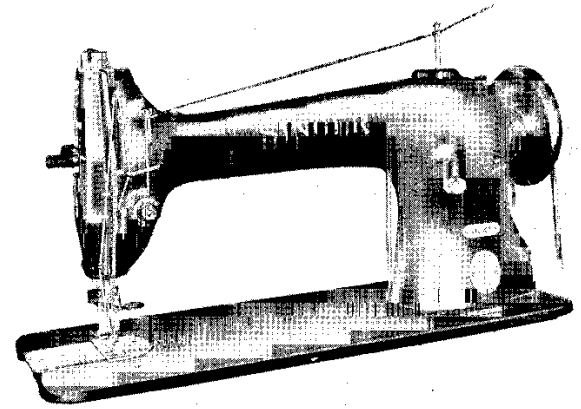

MACHINE No. 96-45

For Light, Medium and Heavy Clothing and Other Work in Cloth. Drop feed. Has vertical trimmer that trims from 1/16 to 1/4 inch from the line of stitching. The machine is fitted with 1/8 inch cutting bar unless otherwise ordered, and an extra 3/16 inch cutting bar and presser foot are also furnished. When a different width is ordered, the extra cutting bar will be one size larger except when 1/4 inch is required. The machine is fitted with heavy gear shafts. The gears are lubricated with oil instead of grease.

Speed up to 3500 R. P. M. according to the material being stitched.

No.	Plate	Name
*127216	-----	Arm with 15404 and two each 15405 and 56015.....
16532	21801	Arm Dowel Pin.....
52182	21801	" Oil Tube with 52184, for oiling 52205.....
52183	21801	Arm Oil Tube with 52184, for oiling 52024 and 127156, for 127193 and 150460.....

From the library of: Diamond Needle Corp

PARTS FOR MACHINE NO. 96-45

No.	Plate	Name
52180	21801	Arm Oil Tube (long) with 52184, for oiling 52022.....
52185	21801	Arm Oil Tube (short) with 42367, for oiling 52022.....
127187	21801	Arm Oil Tube (bent) with 42367, for oiling 127152, for 127193.....
52148	21801	Arm Oil Tube for 52149.....
52149	-----	" " " 52148 with 52150, for oiling 127073 and 127074.....
56015	21801	Arm Oil Tube for oiling 127058.....
52184	22210	" " " Packing (wick) for 52180, 52182 and 52183.....
52150	21801	Arm Oil Tube Packing (braided cotton) for 52149.....
42367	21801	Arm Oil Tube Packing (braided cotton) for 52185 and 127187.....
116E	22213	Arm Screw (back).....
854E	22213	" " (front).....
127024	22206	" Shaft (horizontal).....
127227	-----	" " " 127024 with 52196 127032 and 127223.....
52191	22207	Arm Shaft (horizontal) Flanged Bushing (back).....
52192	-----	Arm Shaft (horizontal) Flanged Bushing (back) 52191 with 52193 and 52194.....
52193	22210	Arm Shaft (horizontal) Flanged Bushing (back) Oil Pad (inside) braided cotton.....
52194	22210	Arm Shaft (horizontal) Flanged Bushing (back) Oil Pad (outside) felt.....
448C	22213	Arm Shaft (horizontal) Flanged Bushing (back) Set Screw.....
52195	22207	Arm Shaft (horizontal) Flanged Bushing (front).....
52196	-----	Arm Shaft (horizontal) Flanged Bushing (front) 52195 with 52193 and 52198.....
52193	22210	Arm Shaft (horizontal) Flanged Bushing (front) Oil Pad (inside) braided cotton.....
52198	22210	Arm Shaft (horizontal) Flanged Bushing (front) Oil Pad (outside) felt.....
435C	22213	Arm Shaft (horizontal) Flanged Bushing (front) Set Screw.....
68350	21801	Arm Shaft (horizontal) Front Bearing Oil Cup.....
127072	21827	Arm Shaft (horizontal) Bevel Gear with two 1036C.....
127070	22216	Arm Shaft (horizontal) Bevel Gear Case (two pieces) with 121E.....

PARTS FOR MACHINE NO. 96-45

No.	Plate	Name
121E	21827	Arm Shaft (horizontal) Bevel Gear Case Screw.....
1036C	21809	Arm Shaft (horizontal) Bevel Gear Set Screw.....
144D	21827	Arm Shaft (horizontal) Screw.....
127058	22210	" " (upright).....
52492	22215	" " " Bushing (lower)....
432C	21809	" " " " " Set Screw.....
52493	22215	Arm Shaft (upright) Bushing (upper)....
435C	22213	" " " " " Set Screw.....
127073	21827	Arm Shaft (upright) Bevel Gear (lower) with two 1259C.....
1259C	21809	Arm Shaft (upright) Bevel Gear (lower) Set Screw.....
127074	21827	Arm Shaft (upright) Bevel Gear (upper) with two 1259C.....
1259C	21809	Arm Shaft (upright) Bevel Gear (upper) Set Screw.....
127079	22216	Arm Side Cover.....
50053W	21827	" " " Thumb Screw.....
52239	22210	" Spool Pin and Thread Eyelet.....
8979	5936	" " " Washer (cloth).....
127192	22207	" Top Cover.....
127193	22207	" " 127192 with 52183, 52239 and 127187.....
158J	21827	Arm Top Cover Screw.....
52187	22216	Balance Wheel (power, disc) 2 3/16 in. pulley, with two 448C.....
52063	22216	Balance Wheel Oil Cover.....
210J	22213	" " " Screw.....
448C	22213	" " " Set Screw.....
*52383	-----	Bed.....
12431	-----	" Slide.....
4307	22207	" " Spring.....
725J	21827	" " " Screw.....
12432	22207	Bed Slide complete, Nos. 4307, 12431 and two 725J.....
52102	-----	Face Plate.....
52053	22210	" " " Thread Guard (lower).....
226J	21809	" " " " " Screw..
52170	22210	" " " " " (upper).....
226J	21809	" " " " " Screw..
52103	22216	Face Plate complete, Nos. 52053, 52102, 52170 and two 226J.....
176J	21809	Face Plate Screw.....
52452	22207	Feed Bar.....
313C	21827	" " " Screw Center.....

No.	Plate	Name
2291	22212	Knife Screw Washer.....
127135	22212	Needle Bar (hollow) with 857H.....
127137	-----	" " 127135 with 127136.....
52200	22212	" " Bushing (lower).....
1133E	21809	" " " " Set Screw....
52111	22212	" " " " (upper).....
1133E	21809	" " " " Set Screw....
52205	22215	" " Connecting Link with 52207..
52206	-----	" " " " 52205 with 24041.....
775E	21809	Needle Bar Connecting Link Cap Screw...
52207	22212	" " " " Lubricating Pad (wood).....
24041	22215	Needle Bar Connecting Stud with 207E...
207E	2834	" " " " Clamping Screw.....
127223	22207	Needle Bar Crank (eccentric) with 1036C 1037C and 1065C.....
127032	22207	Needle Bar Crank (eccentric) Sleeve....
1065C	22213	" " " " Position Screw.....
127136	22212	" " Thread Guide.....
857H	21809	" " Set Screw.....
*52201	-----	Oil Absorbent Wick.....
52202	7732	" " " " 52201 with 52203, for lower cavity in head of arm.....
*52203	-----	Oil Absorbent Wick Wire.....
127191	22209	" Tube with 52184.....
127091	22209	" " Bracket.....
127092	22209	" " " " 127091 with 127191, for oiling Feed Connecting Link.....
52184	22210	Oil Tube Packing (wick).....
12391	22208	Presser Bar (hollow).....
52338	5936	" " Guide Bracket with 223C and 453C.....
453C	5936	Presser Bar Guide Bracket Set Screw....
52016	5936	" " Lifter.....
689C	5936	" " " " Screw.....
1520J	5936	" " " " Nut.....
12327	5936	" " Lifting and Releasing Lever Bracket.....
127108	22208	Presser Bar Spring.....
11170	5936	" " Washer.....
127033	7715	" " Foot, for 1/16 in. to 11/64 in. gauges.....
127034	7715	Presser Foot, for 3/16 in. gauge and above.....

Note: No. 127033, 1/8 in. gauge and No. 127034, 3/16 in. gauge, are sent with this machine unless other gauges are specified on order.

No.	Plate	Name
176J	21809	Presser Foot Screw.....
50373W	22208	Pressure Regulating Thumb Screw.....
127095	-----	Rotating Hook with three 1253C.....
127096	-----	" " 127095 with 127102 and four 1053E.....
*127119	-----	Rotating Hook 127096 with 40274, 127100 and three 1367E.....
127097	21808	Rotating Hook 127096 with 40274 and three 1367E (For agents only).....
127098	-----	Rotating Hook 127119 with 52473.....
40264	21808	" " Bobbin.....
52472	-----	" " " " Case.....
52481	-----	" " " " 52472 with 591F, 1380E and 40394.....
40392	21808	Rotating Hook Bobbin Case Latch.....
125320	21808	" " " " " Lever..
2974	21808	" " " " " " "
		Fulcrum Pin.....
2975	21808	Rotating Hook Bobbin Case Latch Spring.
592E	21808	" " " " " Stop Screw.....
40393	-----	Rotating Hook Bobbin Case Hinge, Nos. 2974, 40392 and 125320.....
591F	21808	Rotating Hook Bobbin Case Tension Regu- lating Screw.....
40394	21808	Rotating Hook Bobbin Case Tension Spring.....
1380E	21808	Rotating Hook Bobbin Case Tension Spring Screw.....
52473	21808	Rotating Hook Bobbin Case complete, Nos. 592E, 2975, 40393 and 52481.....
127099	-----	Rotating Hook Bobbin Case 52473 with 127100 (For agents only).....
127100	21808	Rotating Hook Bobbin Case Holder with 52475 and two 52476.....
52018	21808	Rotating Hook Bobbin Case Holder Posi- tion Bracket.....
704J	21809	Rotating Hook Bobbin Case Holder Posi- tion Bracket Screw.....
*52475	-----	Rotating Hook Bobbin Case Locating Plate.....
*52476	-----	Rotating Hook Bobbin Case Locating Plate Rivet.....
40274	21808	Rotating Hook Section.....
1367E	21808	" " " " Screw.....
1253C	21809	" " " " Set Screw.....
127059	22206	" " " " Shaft.....
127004	22215	" " " " Bushing (back).....

No.	Plate	Name
127043	-----	Rotating Hook Shaft Bushing (back) 127004 with 52045.....
52045	22212	Rotating Hook Shaft Bushing (back) Packing (wick).....
1143C	21809	Rotating Hook Shaft Bushing (back) Set Screw.....
127005	22215	Rotating Hook Shaft Bushing (front)....
127044	-----	" " " " 127005 with 52045.....
54897	21809	Rotating Hook Shaft Bushing (front) Oil Cup.....
52045	22212	Rotating Hook Shaft Bushing (front) Packing (wick).....
1148C	21809	Rotating Hook Shaft Bushing (front) Set Screw.....
127073	21827	Rotating Hook Shaft Bevel Gear with two 1259C.....
127007	22216	Rotating Hook Shaft Bevel Gear Case (two pieces) with 121E and 50234E.
50234E	22213	Rotating Hook Shaft Bevel Gear Case Plug Screw.....
121E	21827	Rotating Hook Shaft Bevel Gear Case Screw.....
1259C	21809	Rotating Hook Shaft Bevel Gear Set Screw.....
127102	21808	Rotating Hook Thread Guard.....
1053E	21809	" " " " Screw.....
52115	22209	Slack Thread Regulator.....
223C	5936	" " " " Set Screw.....
2102	22211	Tension Disc.....
1560C	21809	" Regulating Thumb Nut.....
32572	22211	" Releasing Disc.....
43944	5936	" " " " Lever.....
12398	5936	" " " " Hinge Pin.....
12329	5936	" " " " Spring.....
32574	22211	" " " " Pin.....
2103	22211	" " " " Spring.....
50304C	22211	" " " " Stud.....
52098	-----	" " " " 50304C with 1560C.....
50305C	22211	" " " " Set Screw.....
52397	-----	Tension complete, Nos. 2103, 32572, 32574 52083, 52098, 52094 and two 2102..
52027	22211	Thread Guard (side of arm).....
52454	22215	" Retainer.....
624C	21809	" " " " Set Screw.....
52208	-----	Thread Take-up complete, Nos. 11204, 52025 and 52209.....
52021	22215	Thread Take-up Crank.....

No.	Plate	Name
52209	-----	Thread Take-up Crank 52021 with 775E and 52208.....
1037C	21809	Thread Take-up Crank Position Screw....
1036C	21809	" " " " Set Screw.....
52022	22211	" " " " Lever with 52130.....
52023	21809	" " " " Hinge Pin.....
52024	22215	" " " " Link.....
11204	22215	" " " " Hinge Pin....
435C	22213	" " " " " " Set Screw.....
52130	22211	Thread Take-up Lever Thread Eyelet Bushings.....
52025	-----	Thread Take-up Lever complete, Nos. 52022 to 52024.....
52394	22211	Thread Take-up Spring.....
52083	22211	" " " " Regulator with 50305C.....
448C	22213	Thread Take-up Spring Regulator Set Screw.....
5729	-----	Throat Plate Body.....
5730	7715	" " " " Cutting Bar, for 127036... Note: No. 5730, 3/16 in. gauge, is sent with this machine unless another gauge is specified on order.
52131	7715	Throat Plate Cutting Bar, for 127040... Note: When ordering No. 5730 or 52131, state re- quired distance of trimmed edge from seam.
578D	22213	Throat Plate Cutting Bar Screw.....
127035	7715	" " " " Slide.....
578D	22213	" " " " Adjusting Screw....
127036	7715	Throat Plate (small needle hole) com- plete for 127025, Nos. 5729, 5730, 127035 and three 578D..... Note: No. 127036, 1/8 in. gauge, is sent with this machine unless another gauge is specified on order.
127040	7715	Throat Plate (large needle hole) com- plete, for 127025, Nos. 5729, 52131 127035 and three 578D..... Note: When ordering No. 127036 or 127040, state required distance of trimmed edge from seam.
691F	22213	Throat Plate Screw.....
44212	7734	Drip Pan with four 1 in. wire nails....
15404	-----	Trade Mark.....
15405	-----	" " " " Rivet.....

MACHINE BASE

No.	Plate	Name
19219	7729	Bed Frame Cushion (leather).....
158C	21927	" " " Screw.....
19220	7730	" " " Spring.....
19226	7730	" " " Hinge Connection.....
19398	-----	" " " " 19226 with 211F and 19397.....
19397	7729	Bed Frame Hinge Connection Cap.....
211F	7729	" " " " " Screw....
16555	7730	" " " " Plate.....
14010	7729	" " " " Rivet.....
20067	819	" " " with two each 16555, 19398, four each 19219, 19220, six each 14010, wood screws 1 1/4 in. No.12 and eight 158C.....

ACCESSORIES

No.	Plate	Name
12361	7730	Machine Hinge Connection.....
44139	7730	" " " Plate.....
44140	-----	Machine Hinge complete, Nos. 12361, 44139 and merlized wood screw 1 1/4 in. No. 14.....
12405	7729	Machine Rest (felt).....
41400	22208	" " " Pin.....
120342	21835	Oilier (copper plated) with 120343.....
120343	21835	" Spout, 3 1/2 in. long.....
26026	21835	Screw Driver (large).....
26435	21835	" " " (small).....

BOBBIN WINDERS

BOBBIN WINDER

(SWINGING AUTOMATIC, LEFT HAND)

No.	Plate	Name
41913	21834	Bracket with 457C.....
41583	21834	Frame with 457C.....
34105	21834	" Hinge Pin.....
457C	22213	" " " Set Screw.....
41914	21834	" Spring.....
41585	21834	Pulley with 171D.....

BOBBIN WINDER

No.	Plate	Name
171D	22213	Pulley Set Screw.....
41586	21834	Spindle.....
41587	21834	Stop Latch.....
42614	21834	" " " Hinge Stud.....
457C	22213	" " " " Set Screw.....
7958	22211	" " " Stop Pin.....
41588	21834	" " " Tripping Arm with 185H.....
185H	22213	" " " " Clamping Screw.
150459	21834	Tension Bracket with 460C.....
150460	-----	Tension Bracket complete, Nos. 41593 to 41595, 52183, 52239, 127187, 150459 and two 2455.....
158J	21827	Tension Bracket Screw.....
52239	22210	" " " Spool Pin and Thread Eyelet.....
8879	5936	Tension Bracket Spool Pin Washer (cloth).....
2455	2834	Tension Disc.....
41593	5936	" Spring.....
41594	5936	" Stud.....
480C	7729	" " Set Screw.....
41595	5936	" Thread Guide.....
60845	-----	Bobbin Winder, Nos. 7958, 34105, 41583, 41585 to 41588, 41913, 41914 and 42614.....
41915	21834	Bobbin Winder 60845 with 880E and 25446
150461	-----	Bobbin Winder (swinging automatic, left hand) complete, Nos. 41915 and 150460.....
880E	7729	Bobbin Winder Screw.....
25446	7729	" " " Washer.....

BOBBIN WINDER

(SWINGING AUTOMATIC, RIGHT HAND)

No.	Plate	Name
41339	2833	Base.....
41340	2833	Frame.....
1429D	2834	" Hinge Screw.....
41341	2833	" Spring.....
207J	2834	" " " Screw.....
41342	2833	Pulley with 200F.....
200F	2834	" Set Screw.....
41343	2834	Spindle.....
27306	2834	Spool Pin.....
27307	2833	" Stand.....

BOBBIN WINDER

No.	Plate	Name
27308	2833	Spool Stand complete, Nos. 418E, 1562J, 2106, 10141, 11241, 27306, 27307 and two each 2455 and wood screws 1 in. No. 10.....
11241	2833	Spool Washer (cloth).....
41344	2834	Stop Latch.....
41345	2834	" " Finger.....
152F	2834	" " Screw.....
1430D	2834	" " Hinge Screw.....
1550J	2834	" " Nut.....
41346	2834	" " Lever.....
1430D	2834	" " Hinge Screw.....
2455	2834	Tension Disc.....
1562J	2834	" Regulating Thumb Nut.....
418E	2834	" Screw Stud.....
10141	2834	" Spring.....
2106	2834	" Thread Guide.....
60456	-----	Bobbin Winder, Nos. 152F, 207J, 1429D, 1550J, 41339 to 41346 and three 1430D.....
41347	2833	Bobbin Winder, Nos. 60456 and two each 9331 and wood screws 1 in. No. 10 R.H.B.....
41348	-----	Bobbin Winder (swinging automatic, right hand) complete, Nos. 27308 and 41347
9331	2834	Bobbin Winder Washer.....

BOBBIN WINDER

(SWINGING AUTOMATIC, RIGHT HAND)

FOR POWER TABLE

No.	Plate	Name
225433	22205	Bobbin Winder and Tension Bracket Base.
225453	22204	Frame with 202277 and 225438.....
225454	3471	" Hinge Pin.....
202277	3471	" Oil Packing (wick).....
225438	3471	" Well Cap.....
225455	3471	" Spring.....
225456	3471	" Plunger.....
202473	22204	Pulley with 200380C.....
200380C	3471	" Set Screw.....
225381	22204	Spindle.....
225444	3471	Stop Latch.....
200056E	3471	" Screw.....
225458	3471	" Thumb Lever.....
225459	3471	" Hinge Stud.....

BOBBIN WINDER

No.	Plate	Name
202478	3471	Stop Latch Trip Lever.....
200299H	3471	" " " " Hinge Screw.....
225481	3471	Tension Bracket with 201499B.....
200082D	3471	" " Screw.....
228026	-----	" " Washer.....
2102	3471	" Disc.....
202407	3471	" Spring.....
201499B	3471	" Stud.....
201572B	3471	" Thumb Nut.....
225462	-----	Tension Bracket complete, Nos. 201572B, 202407, 225461 and two 2102.....
225382	22205	Bobbin Winder (swinging automatic, right hand) complete, Nos. 200056E, 200082D, 200299H, 202473, 202478, 225381, 225433, 225444, 225453 to 225456, 225458, 225462, 228026 and two each 225459 and wood screws 3/4 in. No. 12 R.H.B.....

FINGER GUARD

No.	Plate	Name
121356	22211	Finger Guard.....

FOOT LIFTER PARTS

No.	Plate	Name
5596	7732	Bell Crank.....
56848	-----	" " 5596 with 5599 and 5601.....
5599	7732	" " Bracket.....
178E	7729	" " Screw.....
5601	7729	" " Hinge Pin.....
5735	7730	" " Spring.....
5598	7732	Bell Crank complete, Nos. 5735 and 56848.
5670	-----	Chain, length 26 in. to 35 in. with 56864 and 56865.....

Note: When ordering No. 5670, state length required.

4879	7730	Chain Connecting Link.....
56864	7730	" Hook (large).....
56865	7730	" (small).....
20340	22208	Lifting Lever with 448C.....
24940	22208	" Connecting Rod.....

FOOT LIFTER PARTS

No.	Plate	Name
12416	5936	Lifting Lever Connecting Rod Joint.....
76D	7729	" " " " " Hinge Screw.....
1521J	7729	Lifting Lever Connecting Rod Lock Nut..
802D	7729	" " " Hinge Screw.....
12241	5936	" " " Link.....
766D	7729	" " " Hinge Screw.....
16586	22208	" " " Pin.....
448C	22213	" " " Set Screw.....
2763	819	Rock Shaft.....
12242	819	" " Hanger with two wood screws 1 in. No. 10.....
6337	819	Rock Shaft Lifting Bracket with two 356C.....
12243	819	Rock Shaft Lifting Bracket Hook.....
7125	819	" " " " Hook.....
356C	7729	" " " " Set Screw
356C	7729	" " " " Set Screw...
2770	819	" " " Stop Dog with 356C.....
356C	7729	" " " " Set Screw.....
4880	819	Rock Shaft complete, Nos.2763,2770,7125 12243 and two each 6337 and 12242.
4881	819	Treadle.....
4882	22208	" Shaft.....
4883	22208	" Spring.....
4884	819	" Stand.....
4885	819	Treadle complete,Nos.4879,4881 to 4884 and two wood screws 1 in. No. 16..
127037	-----	Foot Lifter complete, Nos.76D,766D,802D 1521J, 4880, 4885, 5598,5670,12241 12416, 16586, 20340, 24940 and two 178E.....

KNEE LIFTER PARTS

No.	Plate	Name
5596	7732	Bell Crank.....
56848	-----	" " 5596 with 5599 and 5601.....
5599	7732	" " Bracket.....
178E	7729	" " " Screw.....
5601	7729	" " Hinge Pin.....
5735	7730	" " Spring.....
5598	7732	Bell Crank complete, Nos.5735 and 56848
20340	22208	Lifting Lever with 448C.....
24940	22208	" " Connecting Rod.....
12416	5936	" " " " Joint.....

KNEE LIFTER PARTS

No.	Plate	Name
76D	7729	Lifting Lever Connecting Rod Joint Hinge Screw.....
1521J	7729	Lifting Lever Connecting Rod Lock Nut..
802D	7729	" " Hinge Screw.....
12241	5936	" " Link.....
766D	7729	" " " Hinge Screw.....
16586	22208	" " " Pin.....
448C	22213	" " " Set Screw.....
2763	22205	Rock Shaft.....
7539	22205	" " Hanger with two wood screws 1 in. No. 10.....
2765	22205	Rock Shaft Knee Arm.....
2766	22205	" " " Hub with 356C.....
356C	7729	" " " " Set Screw.....
2768	-----	Rock Shaft Knee Arm complete, Nos. 2765 to 2767.....
2767	22205	Rock Shaft Knee Plate with 356C.....
356C	7729	" " " " Set Screw.....
6337	22205	" " Lifting Bracket with two 356C.....
2778	22205	Rock Shaft Lifting Bracket Hook.....
356C	7729	" " " " Set Screw
356C	7729	" " " " Set Screw...
2770	22205	" " Stop Dog with 356C.....
356C	7729	" " " " Set Screw.....
12250	22205	Rock Shaft complete, Nos.2763,2768,2778 6337 and two each 2770 and 7539...
127038	-----	Knee Lifter complete (power table) Nos. 76D, 766D, 802D, 1521J, 5598,12241 12250, 12416, 16586, 20340, 24940 and two 178E.....

KNIFE GRINDER

FOR 127026 AND 127027

No.	Plate	Name
27565	1104	Emery Wheel, 2 in. diam.....
1508J	22214	" " Clamping Nut.....
27822	22214	" " " Washer.....
27567	22214	" " Shaft.....
60934	-----	" " " 27567 with 1508J, 27565, 27569 and 27822.....
27568	22214	Emery Wheel Shaft Oil Hole Cover (rubber).....
27569	22214	Emery Wheel Shaft Pulley.....

KNIFE GRINDER

No.	Plate	Name
310K	22214	Emery Wheel Shaft Screw Center.....
1516J	22214	" " " " " Nut.....
27564	1104	Frame with 27574.....
899J	22214	Knife Clamping Screw.....
126304	-----	" Holder Body.....
126305	22214	Knife Holder complete, Nos. 899J, 27660 and 126304.....
27323	22214	Knife Holder Guide Bar.....
27572	1104	" " " " Bracket with 27574.....
310K	22214	Knife Holder Guide Bar Bracket Screw Center.....
1516J	22214	Knife Holder Guide Bar Bracket Screw Center Nut.....
27573	22214	Knife Holder Guide Bar Bracket Spring..
27574	22214	" " " " " Hook
27659	22214	" " Stop Collar with 237K.....
237K	22214	" " " " Set Screw....
27660	22211	" Position Pin.....
261J	22214	" Regulating Thumb Screw.....
27662	1104	Wrench for 1508 and 1516.....
•60583	5918	Knife Grinder Nos. 261J, 27323, 27564, 27572, 27573, 27659, 60934, two 27568 and four each 310K and 1516J.....
126306	-----	Knife Grinder complete, Nos. 27662, 60583 126305 and three wood screws 1 in. No. 10.....

THREAD UNWINDER

FOR TWO SPOOLS OR TWO LARGE CONES OF THREAD

No.	Plate	Name
225257	20335	Spool Rest with 201018C.....
150203	20335	" " Cushion (felt).....
225388	20335	" " Rod.....
200383C	7729	" " Set Screw.....
201018C	7729	" " Set Screw.....
202490	20335	" Stand with 200383C.....
225391	20335	Thread Guide.....
201696J	7729	" " Lock Nut.....
225326	20335	" " Position Cup.....
225324	20335	" " Rod with 208E and 225322..
208E	7729	" " Screw.....
225322	7729	" " Washer.....

THREAD UNWINDER

No.	Plate	Name
225258	20335	Thread Unwinder complete, Nos. 201696J, 202490, 225257, 225324, 225326, 225388 two each 150203, 225391 and three wood screws 7/8 in. No. 12.....
27739	22204	Thread Cone (wood) for large cones....
225390	22204	" " Holder for inverted cones..

Note: Nos. 27739 and 225390 are used with, but not included in 225258.

WRENCHES

No.	Plate	Name
8909	21835	Wrench for 1513 and 1518.....
8908	21835	" " 1519 and 1520.....

Genuine Singer Needles should be used
in Singer Machines.
These Needles and their Containers
are marked with the
Company's Trade Mark "SIMANCO." 1

Needles in Containers marked
"For Singer Machines"
are not Singer made needles. 2

NUMERICAL LIST OF PARTS

No.	Plate	Name
76D	7729	Lifting Lever Connecting Rod Joint Hinge Screw, for 127037 and 127038
116E	22213	Arm Screw (back).....
121E	21827	" Shaft (horizontal) Bevel Gear Case Screw for 127070.....
121E	21827	Rotating Hook Shaft Bevel Gear Case Screw for 127007.....
144D	21827	Arm Shaft (horizontal) Screw.....
152F	2834	Bobbin Winder Stop Latch Finger Screw for 60456.....
157J	21827	Feed Lifting Rock Shaft Crank Clamping Screw for 12376.....
157J	21827	Feed Rock Shaft Crank Clamping Screw for 29633.....
158J	21827	Arm Top Cover Screw.....
158C	21827	Bed Frame Cushion Screw for 20087.....
158C	21827	Bobbin Winder Tension Bracket Screw for 150460.....
171D	22213	Bobbin Winder Pulley Set Screw for 41585.....
176J	21809	Face Plate Screw.....
176J	21809	Presser Foot Screw.....
178E	7729	Bell Crank Bracket Screw for 127037 and 127038.....
185H	22213	Bobbin Winder Stop Latch Tripping Arm Clamping Screw for 41588.....
191C	22213	Knife Bar Crank Set Screw for 24431....
200F	2834	Bobbin Winder Pulley Set Screw for 41342.....
207J	2834	Bobbin Winder Frame Spring Screw for 60456.....
207E	2834	Needle Bar Connecting Stud Clamping Screw for 24041.....
208E	7729	Thread Unwinder Thread Guide Rod Screw for 225324.....
210J	22213	Balance Wheel Oil Cover Screw.....
211F	7729	Bed Frame Hinge Connection Cap Screw for 19398.....
223J	5936	Knife Screw for 52108.....
223C	5936	Slack Thread Regulator Set Screw for 52338.....
226J	21809	Face Plate Thread Guard (lower) Screw for 52103.....
226J	21809	Face Plate Thread Guard (upper) Screw for 52103.....
237K	22214	Knife Grinder Knife Holder Stop Collar Set Screw for 27659.....

Genuine Singer Needles should be used in Singer Machines. These Needles and their Containers are marked with the Company's Trade Mark "SIMANCO." 1

Needles in Containers marked "For Singer Machines" are not Singer made needles. 2

No.	Plate	Name
261J	22214	Knife Grinder Knife Regulating Thumb Screw for 60583.....
310K	22214	Knife Grinder Emery Wheel Shaft Screw Center for 60583.....
310K	22214	Knife Grinder Knife Holder Guide Bar Bracket Screw Center for 60583....
313C	21827	Feed Bar Screw Center for 56813.....
356C	7729	Rock Shaft Knee Arm Hub Set Screw for 2766.....
356C	7729	Rock Shaft Knee Plate Set Screw for 2767.....
356C	7729	Rock Shaft Lifting Bracket Hook Set Screw for 6337.....
356C	7729	Rock Shaft Lifting Bracket Set Screw for 6337.....
356C	7729	Rock Shaft Stop Dog Set Screw for 2770.
375C	21827	Feed Connecting Link Hinge Screw for 52393.....
375C	21827	Feed Forked Connection Hinge Screw....
375C	21827	" Lifting Rock Shaft Connecting Rod Hinge Screw.....
418E	2834	Bobbin Winder Tension Screw Stud for 27308.....
432C	21809	Arm Shaft (upright) Bushing (lower) Set Screw.....
435C	22213	Arm Shaft (horizontal) Flanged Bushing (front) Set Screw.....
435C	22213	Arm Shaft (upright) Bushing (upper) Set Screw.....
435C	22213	Thread Take-up Lever Link Hinge Pin Set Screw.....
446C	22213	Feed and Feed Lifting Eccentric Set Screw for 127224.....
448C	22213	Arm Shaft (horizontal) Flanged Bushing (back) Set Screw.....
448C	22213	Balance Wheel Set Screw for 52187.....
448C	22213	Lifting Lever Pin Set Screw for 20340..
448C	22213	Thread Take-up Spring Regulator Set Screw.....
453C	5936	Presser Bar Guide Bracket Set Screw for 52338.....
457C	22213	Bobbin Winder Frame Hinge Pin Set Screw for 41583.....
457C	22213	Bobbin Winder Stop Latch Hinge Stud Set Screw for 41913.....
460C	7729	Bobbin Winder Tension Stud Set Screw for 150459.....
578D	22213	Throat Plate Cutting Bar Screw for 127036 and 127040.....

No.	Plate	Name
578D	22213	Throat Plate Slide Adjusting Screw for 127036 and 127040.....
591F	21808	Rotating Hook Bobbin Case Tension Regulating Screw for 52481.....
592E	21808	Rotating Hook Bobbin Case Latch Stop Screw for 52473.....
620C	22213	Knife Adjusting Screw for 52108.....
621J	22210	" Bar Lifting Spring Guide Bracket Screw for 52107.....
624C	21809	Thread Retainer Set Screw.....
647C	22213	Knife Bar Driving Crank Bracket Screw..
689C	5936	Presser Bar Lifter Screw.....
691F	22213	Throat Plate Screw.....
704J	21809	Rotating Hook Bobbin Case Holder Position Bracket Screw.....
725J	21827	Bed Slide Spring Screw for 12432.....
766D	7729	Lifting Lever Link Hinge Screw for 127037 and 127038.....
775E	21809	Needle Bar Connecting Link Cap Screw for 52209.....
802D	7729	Lifting Lever Hinge Screw for 127037 and 127038.....
818D	22213	Feed Regulator Thumb Screw.....
854E	22213	Arm Screw (front).....
857H	21809	Needle Set Screw for 127135.....
880E	7729	Bobbin Winder Screw for 41915.....
899J	22214	Knife Grinder Knife Clamping Screw for 126305.....
966E	21827	Feed Lifting Rock Shaft Connecting Rod Cap Screw for 127156.....
1036C	21809	Arm Shaft (horizontal) Bevel Gear Set Screw for 127072.....
1036C	21809	Thread Take-up Crank Set Screw for 127223.....
1037C	21809	Thread Take-up Crank Position Screw for 127223.....
1053E	21809	Rotating Hook Thread Guard Screw for 127096.....
1085C	22213	Needle Bar Crank Position Screw for 127223.....
1128E	22213	Feed Regulator Hinge Screw.....
1133E	21809	Needle Bar Bushing (lower) Set Screw...
1133E	21809	" " (upper) Set Screw...
1143C	21809	Rotating Hook Shaft Bushing (back) Set Screw.....
1148C	21809	Rotating Hook Shaft Bushing (front) Set Screw.....
1162C	22213	Knife Bar Crank Coupling Pin for 24432.
1253C	21809	Rotating Hook Set Screw for 127095.....

NUMERICAL LIST OF PARTS

No.	Plate	Name
1259C	21809	Arm Shaft (upright) Bevel Gear (lower) Set Screw for 127073.....
1259C	21809	Arm Shaft (upright) Bevel Gear (upper) Set Screw for 127074.....
1259C	21809	Rotating Hook Shaft Bevel Gear Set Screw for 127073.....
1367E	21808	Rotating Hook Section Screw for 127097 and 127119.....
1380E	21808	Rotating Hook Bobbin Case Tension Spring Screw for 52481.....
1429D	2834	Bobbin Winder Frame Hinge Screw for 60456.....
1430D	2834	Bobbin Winder Stop Latch Hinge Screw for 60456.....
1430D	2834	Bobbin Winder Stop Latch Lever Hinge Screw for 60456.....
1508J	22214	Knife Grinder Emery Wheel Clamping Nut for 60934.....
1513J	21827	Feed Lifting Rock Shaft Screw Center Nut for 52097.....
1513J	21827	Feed Rock Shaft Screw Center Nut for 52097.....
1516J	22214	Knife Grinder Emery Wheel Shaft Screw Center Nut for 60583.....
1516J	22214	Knife Grinder Knife Holder Guide Bar Bracket Screw Center Nut for 60583
1518J	21827	Feed Connecting Link Hinge Screw Nut for 52393.....
1518J	21827	Feed Forked Connection Hinge Screw Nut.
1518J	21827	" Lifting Rock Shaft Connecting Rod Hinge Screw Nut.....
1519J	21809	Feed Bar Screw Center Nut for 56813....
1520J	5936	Presser Bar Lifter Screw Nut.....
1521J	7729	Lifting Lever Connecting Rod Lock Nut for 127037 and 127038.....
1550J	2834	Bobbin Winder Stop Latch Hinge Screw Nut for 60456.....
1560C	21809	Tension Regulating Thumb Nut for 52098.
1562J	2834	Bobbin Winder Tension Regulating Thumb Nut for 27308.....
1564D	22213	Knife Bar Crank Coupling Pin Head for 24432.....
1813	21827	Feed Lifting Rock Shaft Crank Roller and Stud for 12376.....
2022	22211	Knife Bar Crank Pin for 127029.....
2102	3471	Bobbin Winder Tension Disc for 225462..
2102	22211	Tension Disc for 52397.....
2103	22211	" Spring for 52397.....

NUMERICAL LIST OF PARTS

No.	Plate	Name
2106	2834	Bobbin Winder Tension Thread Guide for 27308.....
2291	22212	Knife Screw Washer for 52108.....
2297	22210	" Bar Crank Coupling Pin Spring for 24432.....
2301	22210	Knife Bar Stop Pin for 52104.....
2455	2834	Bobbin Winder Tension Disc for 27308 and 150460.....
2523	22210	Knife Bar Lifting Spring Guide Pin for 24906.....
2763	819	Rock Shaft for 4880 and 12250.....
2765	22205	" " Knee Arm for 2768.....
2766	22205	" " " Hub with 356C, for 2768.....
2767	22205	Rock Shaft Knee Plate with 356C, for 2768.....
2768	-----	Rock Shaft Knee Arm complete for 12250, Nos. 2765 to 2767.....
2770	819	Rock Shaft Stop Dog with 356C, for 4880 and 12250.....
2778	22205	Rock Shaft Lifting Bracket Hook for 12250.....
2974	21808	Rotating Hook Bobbin Case Latch Lever Fulcrum Pin for 40393.....
2975	21808	Rotating Hook Bobbin Case Latch Spring for 52473.....
4307	22207	Bed Slide Spring for 12432.....
4879	7730	Chain Connecting Link for 4885.....
4880	819	Rock Shaft complete for 127037, Nos. 2763 2770, 7126, 12243 and two each 6337 and 12242.....
4881	819	Treadle for 4885.....
4882	22208	" Shaft for 4885.....
4883	22208	" Spring for 4885.....
4884	819	" Stand for 4885.....
4885	819	Treadle complete for 127037, Nos. 4879, 4881 to 4884 and two wood screws 1 in. No. 16.....
5596	7732	Bell Crank for 56848.....
5598	7732	Bell Crank complete for 127037 and 127038, Nos. 5735 and 56848.....
5599	7732	Bell Crank Bracket for 56848.....
5601	7729	" Hinge Pin for 56848.....
5670	-----	Chain, length 26 in. to 35 in. with 56864 and 56865, for 127037.....
5729	-----	Throat Plate Body for 127036 and 127040
5730	7715	" Cutting Bar for 127036.....
5735	7730	Bell Crank Spring for 5598.....

NUMERICAL LIST OF PARTS

No.	Plate	Name
6337	819	Rock Shaft Lifting Bracket with two 356C, for 4880 and 12250.....
7125	819	Rock Shaft Lifting Bracket Hook for 4880.....
7539	22205	Rock Shaft Hanger with two wood screws 1 in. No. 10, for 12250.....
7958	22211	Bobbin Winder Stop Latch Stop Pin for 60845.....
8879	5938	Arm Spool Pin Washer (cloth).....
8879	5986	Bobbin Winder Tension Bracket Spool Pin Washer (cloth).....
8908	21835	Wrench for 1519 and 1520.....
8909	21835	" " 1513 and 1518.....
9331	2834	Bobbin Winder Washer for 41347.....
10141	2834	" " Tension Spring for 27308.....
11170	5936	Presser Bar Spring Washer.....
11204	22215	Thread Take-up Lever Link Hinge Pin for 52208.....
11241	2833	Bobbin Winder Spool Washer (cloth) for 27308.....
12241	5936	Lifting Lever Link for 127037 and 127038.....
12242	819	Rock Shaft Hanger with two wood screws 1 in. No. 10, for 4880.....
12243	819	Rock Shaft Lifting Bracket Hook for 4880.....
12250	22205	Rock Shaft complete for 127038, Nos. 2763 2768, 2778, 6337 and two each 2770 and 7539.....
12327	5936	Presser Bar Lifting and Releasing Lever Bracket.....
12329	5936	Tension Releasing Lever Spring.....
12361	7730	Machine Hinge Connection for 44140.....
12376	22207	Feed Lifting Rock Shaft Crank with 157J and 1813, for 52385.....
12391	22208	Presser Bar (hollow).....
12398	5936	Tension Releasing Lever Hinge Pin.....
12405	7729	Machine Rest (felt) Accessories.....
12416	5936	Lifting Lever Connecting Rod Joint for 127037 and 127038.....
12431	-----	Bed Slide for 12432.....
12432	22207	Bed Slide complete, Nos. 4307, 12431 and two 725J.....
14010	7729	Bed Frame Hinge Plate Rivet for 20067..
*15404	-----	Trade Mark for 127216.....
15405	-----	" Rivet for 127216.....
16532	21801	Arm Dowel Pin.....
16555	7730	Bed Frame Hinge Plate for 20067.....

NUMERICAL LIST OF PARTS

No.	Plate	Name
16564	22209	Knife Bar Driving Crank Bracket for 127029.....
16586	22208	Lifting Lever Pin for 127037 and 127038
19219	7729	Bed Frame Cushion (leather) for 20067..
19220	7730	" " Spring for 20067.....
19226	7730	" " Hinge Connection for 19398...
19397	7729	" " " " " 19398...
19398	-----	" " " " " 19226 with 211F and 19397, for 20067.....
20067	819	Bed Frame with two each 16555, 19398, four each 19219, 19220, six each 14010, wood screws 1 1/4 in. No. 12 and eight 158C.....
20284	22209	Feed Forked Connection for 52393.....
20340	22208	Lifting Lever with 448C, for 127037 and 127038.....
24041	22215	Needle Bar Connecting Stud with 207E, for 52206.....
24109	22212	Knife Holder Handle for 52107.....
24122	22210	" Bar Lifting Spring.....
24123	22210	" " " " Case.....
*24124	22210	" " " " Guide for 24906
*24125	22210	" " " " Bracket for 24906.....
24431	22207	Knife Bar Crank with 191C, for 24432...
24432	-----	Knife Bar Crank complete, for 127029, Nos. 1162C, 1564D, 2297 and 24431.
24906	-----	Knife Bar Lifting Spring Guide 24124 with 2523 and 24125, for 52107....
24940	22208	Lifting Lever Connecting Rod for 127037 and 127038.....
25446	7729	Bobbin Winder Screw Washer for 41915...
26026	21835	Screw Driver (large) Accessories.....
26485	21835	" " (small) Accessories.....
27306	2834	Bobbin Winder Spool Pin for 27308.....
27307	2833	" " Stand for 27308....
27308	2833	Bobbin Winder Spool Stand complete for 41348, Nos. 418E, 1562J, 2106, 10141, 11241, 27306, 27307 and two each 2455 and wood screws 1 in. No. 10.
27323	22214	Knife Grinder Knife Holder Guide Bar for 60583.....
27564	1104	Knife Grinder Frame with 27574, for 60583.....
27565	1104	Knife Grinder Emery Wheel, 2 in. diam., for 60934.....
27567	22214	Knife Grinder Emery Wheel Shaft for 60934.....

NUMERICAL LIST OF PARTS

No.	Plate	Name
27568	22214	Knife Grinder Emery Wheel Shaft O11 Hole Cover (rubber) for 60583.....
27569	22214	Knife Grinder Emery Wheel Shaft Pulley for 60934.....
27572	1104	Knife Grinder Knife Holder Guide Bar Bracket with 27574, for 60583.....
27573	22214	Knife Grinder Knife Holder Guide Bar Bracket Spring for 60583.....
27574	22214	Knife Grinder Knife Holder Guide Bar Bracket Spring Hook for 27564 and 27572.....
27659	22214	Knife Grinder Knife Holder Stop Collar with 237K, for 60583.....
27660	22211	Knife Grinder Knife Position Pin for 126305.....
27662	1104	Knife Grinder Wrench for 1508 and 1516, for 126306.....
27739	22204	Thread Unwinder Thread Cone (wood) for large cones, for 225258.....
27822	22214	Knife Grinder Emery Wheel Clamping Nut Washer for 60934.....
29633	22207	Feed Rock Shaft Crank with 157J, for 52387.....
32572	22211	Tension Releasing Disc for 52397.....
32574	22211	" " Pin for 52397.....
34105	21834	Bobbin Winder Frame Hinge Pin for 60845
40264	21808	Rotating Hook Bobbin.....
40274	21808	" " Section for 127097 and 127119.....
40392	21808	Rotating Hook Bobbin Case Latch for 40393.....
40393	-----	Rotating Hook Bobbin Case Hinge, Nos. 2974, 40392 and 125320, for 52473..
40394	21808	Rotating Hook Bobbin Case Tension Spring for 52481.....
41339	2833	Bobbin Winder Base for 60456.....
41340	2833	" " Frame for 60456.....
41341	2833	" " Spring for 60456...
41342	2833	" " Pulley with 200F, for 60456.....
41343	2834	Bobbin Winder Spindle for 60456.....
41344	2834	" " Stop Latch for 60456.....
41345	2834	" " Finger for 60456.....
41346	2834	Bobbin Winder Stop Latch Lever for 60456.....
41347	2833	Bobbin Winder Nos. 60456 and two each 9331 and wood screws 1 in. No. 10 R.H.B., for 41348.....

NUMERICAL LIST OF PARTS

No.	Plate	Name
41348	-----	Bobbin Winder (swinging automatic, right hand) complete, Nos. 27308 and 41347.....
41400	22208	Machine Rest Pin.....
41583	21834	Bobbin Winder Frame with 457C, for 60845
41585	21834	" " Pulley with 171D, for 60845.....
41586	21834	Bobbin Winder Spindle for 60845.....
41587	21834	" " Stop Latch for 60845.....
41588	21834	" " " Tripping Arm with 185H, for 60845.....
41593	5936	Bobbin Winder Tension Spring for 150480
41594	5936	" " Stud for 150480..
41595	5936	" " Thread Guide for 150460.....
41913	21834	Bobbin Winder Bracket with 457C, for 60845.....
41914	21834	Bobbin Winder Frame Spring for 60845...
41915	21834	" " 60845 with 880E and 25446 for 150461.....
42367	21801	Arm Oil Tube Packing (braided cotton) for 52185 and 127187.....
42614	21834	Bobbin Winder Stop Latch Hinge Stud for 60845.....
43944	5936	Tension Releasing Lever.....
44139	7730	Machine Hinge Plate for 44140.....
44140	-----	Machine Hinge complete, Nos. 12361, 44139 and merlized wood screw 1 1/4 in. No. 14 (Accessories).....
44212	7734	Drip Pan with four 1 in. wire nails....
50053W	21827	Arm Side Cover Thumb Screw.....
50083C	21827	Feed Connecting Link Hinge Stud Set Screw for 52074.....
50117E	21827	Feed Dog Screw.....
50117E	21827	Knife Holder Handle Screw for 52107....
50117E	21827	" " Screw for 52107.....
50191C	21827	Feed Lifting Rock Shaft Screw Center for 52097.....
50191C	21827	Feed Rock Shaft Screw Center for 52097.
50234E	22213	Rotating Hook Shaft Bevel Gear Case Plug Screw for 127007.....
50304C	22211	Tension Stud for 52098.....
50305C	22211	" " Set Screw for 52083.....
50373W	22208	Pressure Regulating Thumb Screw.....
52016	5936	Presser Bar Lifter.....
52018	21808	Rotating Hook Bobbin Case Holder Position Bracket.....
52021	22215	Thread Take-up Crank for 52209.....

NUMERICAL LIST OF PARTS

No.	Plate	Name
52022	22211	Thread Take-up Lever with 52130, for 52025.....
52023	21809	Thread Take-up Lever Hinge Pin for 52025.....
52024	22215	Thread Take-up Lever Link for 52025....
52025	-----	Thread Take-up Lever complete for 52208 Nos. 52022 to 52024.....
52027	22211	Thread Guard (side of arm).....
52045	22212	Rotating Hook Shaft Bushing (back) Packing (wick) for 127043.....
52045	22212	Rotating Hook Shaft Bushing (front) Packing (wick) for 127044.....
52053	22210	Face Plate Thread Guard (lower) for 52103.....
52063	22216	Balance Wheel Oil Cover.....
52073	21827	Feed Connecting Link Hinge Stud for 52118.....
52074	22207	Feed Regulator with 50083C, for 52118..
52083	22211	Thread Take-up Spring Regulator with 50305C, for 52397.....
52097	-----	Feed Lifting Rock Shaft Screw Center 50191C with 1513J.....
52097	-----	Feed Rock Shaft Screw Center 50191C with 1513J.....
52098	-----	Tension Stud 50304C with 1560C, for 52397.....
52102	-----	Face Plate for 52103.....
52103	22216	Face Plate complete, Nos. 52053, 52102, 52170 and two 226J.....
52104	22209	Knife Bar with 2301 for 52107.....
52107	-----	Knife Bar complete, Nos. 821J, 24109, 24906, 52104, 52108 and three 50117E
52108	22212	Knife Holder with 620C, 2291 and two 223J, for 52107.....
52111	22212	Needle Bar Bushing (upper).....
52115	22209	Slack Thread Regulator.....
52118	-----	Feed Regulator 52074 with 52073.....
52130	22211	Thread Take-up Lever Thread Eyelet Bushing for 52022.....
52131	7715	Throat Plate Cutting Bar for 127040....
52148	21801	Arm Oil Tube for 52149.....
52149	-----	" " 52148 with 52150, for oiling 127073 and 127074.....
52150	21801	Arm Oil Tube Packing (braided cotton) for 52149.....
52185	21827	Feed Connecting Link for 52393.....
52170	22210	Face Plate Thread Guard (upper) for 52103.....

NUMERICAL LIST OF PARTS

No.	Plate	Name
52180	21801	Arm Oil Tube (long) with 52184, for oiling 52022.....
52182	21801	Arm Oil Tube with 52184, for oiling 52205.....
52183	21801	Arm Oil Tube with 52184, for oiling 52024 and 127156, for 127193 and 150460.....
52184	22210	Arm Oil Tube Packing (wick) for 52180, 52182 and 52183.....
52184	22210	Oil Tube Packing (wick) for 127191.....
52185	21801	Arm Oil Tube (short) with 42367, for oiling 52022.....
52187	22216	Balance Wheel (power, disc) 2 3/16 in. pulley, with two 448C.....
52191	22207	Arm Shaft (horizontal) Flanged Bushing (back) for 52192.....
52192	-----	Arm Shaft (horizontal) Flanged Bushing (back) 52191 with 52193 and 52194.
52193	22210	Arm Shaft (horizontal) Flanged Bushing (back) Oil Pad (inside) braided cotton, for 52192.....
52193	22210	Arm Shaft (horizontal) Flanged Bushing (front) Oil Pad (inside) braided cotton, for 52196.....
52194	22210	Arm Shaft (horizontal) Flanged Bushing (back) Oil Pad (outside) felt, for 52192.....
52195	22207	Arm Shaft (horizontal) Flanged Bushing (front) for 52196.....
52196	-----	Arm Shaft (horizontal) Flanged Bushing (front) 52195 with 52193 and 52198 for 127227.....
52198	22210	Arm Shaft (horizontal) Flanged Bushing (front) Oil Pad (outside) felt, for 52196.....
52200	22212	Needle Bar Bushing (lower).....
*52201	-----	Oil Absorbent Wick for 52202.....
52202	7732	" " 52201 with 52203, for lower cavity in head of arm.....
*52203	-----	Oil Absorbent Wick Wire for 52202.....
52205	22215	Needle Bar Connecting Link with 52207, for 52206.....
52206	-----	Needle Bar Connecting Link 52205 with 24041, for 52209.....
52207	22212	Needle Bar Connecting Link Lubricating Pad (wood) for 52205.....
52208	-----	Thread Take-up complete, Nos. 11204, 52025 and 52209.....

NUMERICAL LIST OF PARTS

No.	Plate	Name
52209	-----	Thread Take-up Crank 52021 with 775E and 52206, for 52208.....
52210	21827	Feed and Feed Lifting Eccentric Lubricating Pad (long) wood for 127224.
52211	21827	Feed and Feed Lifting Eccentric Lubricating Pad (short) wood for 127224
52239	22210	Arm Spool Pin and Thread Eyelet for 127193.....
52239	22210	Bobbin Winder Tension Bracket Spool Pin and Thread Eyelet for 150460.....
52338	5936	Presser Bar Guide Bracket with 223C and 453C.....
52359	22210	Feed Regulator Thumb Screw Stop.....
52383	-----	Bed.....
52384	22206	Feed Lifting Rock Shaft for 52385.....
52385	-----	Feed Lifting Rock Shaft complete, Nos. 12376 and 52384.....
52386	22206	Feed Rock Shaft for 52387.....
52387	-----	Feed Rock Shaft complete, Nos. 29633 and 52386.....
52393	-----	Feed Forked Connection 20284 with 375C, 1518J and 52165.....
52394	22211	Thread Take-up Spring for 52397.....
52397	-----	Tension complete, Nos. 2103, 32572, 32574, 52083, 52098, 52394 and two 2102....
52452	22207	Feed Bar.....
52454	22215	Thread Retainer.....
52472	-----	Rotating Hook Bobbin Case for 52481....
52473	21808	Rotating Hook Bobbin Case complete for 127098 and 127099, Nos. 592E, 2975, 40393 and 52481.....
52475	-----	Rotating Hook Bobbin Case Locating Plate for 127100.....
52476	-----	Rotating Hook Bobbin Case Locating Plate Rivet for 127100.....
52481	-----	Rotating Hook Bobbin Case 52472 with 591F, 1380E and 40394, for 52473..
52492	22215	Arm Shaft (upright) Bushing (lower)....
52493	22215	" " " (upper)....
54897	21809	Rotating Hook Shaft Bushing (front) Oil Cup.....
56015	21801	Arm Oil Tube for oiling 127058, for 127216.....
56813	-----	Feed Bar Screw Center 313C with 1519J..
56848	-----	Bell Crank 5596 with 5599 and 5601, for 5598.....
56864	7730	Chain Hook (large) for 5670.....
56865	7730	" " (small) for 5670.....

NUMERICAL LIST OF PARTS

No.	Plate	Name
60458	-----	Bobbin Winder, Nos. 152F, 207J, 1429D, 1550J, 41339 to 41346 and three 1430D, for 41347.....
60583	5918	Knife Grinder, Nos. 261J, 27323, 27564, 27572, 27573, 27659, 60934, two 27568 and four each 310K and 1516J, for 128306.....
60845	-----	Bobbin Winder, Nos. 7958, 34105, 41583, 41585 to 41588, 41913, 41914 and 42614, for 41915.....
60934	-----	Knife Grinder Emery Wheel Shaft 27567 with 1508J, 27565, 27569 and 27822, for 60583.....
68350	21801	Arm Shaft (horizontal) Front Driving Oil Cup.....
120342	21835	Oiler (copper plated with 120343 (Accessories).....
120343	21835	Oiler Spout, 3 1/2 in. long, for 120342
121356	22211	Finger Guard.....
125320	21808	Rotating Hook Bobbin Case Latch Lever for 40393.....
126304	-----	Knife Grinder Knife Holder Body for 126305.....
126305	22214	Knife Grinder Knife Holder complete for 126306, Nos. 899J, 27660 and 126304
126306	-----	Knife Grinder complete, Nos. 27662, 60583, 126305 and three wood screws 1 in. No. 10.....
127004	22215	Rotating Hook Shaft Bushing (back) for 127043.....
127005	22215	Rotating Hook Shaft Bushing (front) for 127044.....
127007	22216	Rotating Hook Shaft Bevel Gear Case (two pieces) with 121E and 50234E..
127024	22206	Arm Shaft (horizontal) for 127227.....
127025	7715	Feed Dog, 9 teeth (12 teeth to the inch) for 127036 and 127040.....
127026	22210	Knife (narrow).....
127027	22210	" (wide).....
127028	22209	" Bar Driving Crank (forked) for 127029.....
127029	-----	Knife Bar Driving Crank Bracket complete, Nos. 2022, 16564, 24432 and 127028.....
127032	22207	Needle Bar Crank (eccentric) Sleeve for 127227.....
127033	7715	Presser Foot, for 1/16 in. to 11/64 in. gauges.....

No.	Plate	Name
127034	7715	Presser Foot, for 3/16 in. gauge and above.....
127035	7715	Throat Plate Slide, for 127036 and 127040.....
127036	7715	Throat Plate (small needle hole) complete for 127025, Nos. 5729, 5730, 127035 and three 578D.....
127037	-----	Foot Lifter complete, Nos. 76D, 766D, 802D 1521J, 4880, 4885, 5598, 5670, 12241, 12416, 16586, 20340, 24940 and two 178E.....
127038	-----	Knee Lifter complete (power table) Nos. 76D, 766D, 802D, 1521J, 5598, 12241, 12250, 12416, 16586, 20340, 24940 and two 178E.....
127040	7715	Throat Plate (large needle hole) complete, for 127025, Nos. 5729, 52131 127035, and three 578D.....
127043	-----	Rotating Hook Shaft Bushing (back) 127004 with 52045.....
127044	-----	Rotating Hook Shaft Bushing (front) 127005 with 52045.....
127058	22210	Arm Shaft (upright).....
127059	22206	Rotating Hook Shaft.....
127070	22216	Arm Shaft (horizontal) Bevel Gear Case (two pieces) with 121E.....
127072	21827	Arm Shaft (horizontal) Bevel Gear with two 1036C.....
127073	21827	Arm Shaft (upright) Bevel Gear (lower) with two 1259C.....
127073	21827	Rotating Hook Shaft Bevel Gear with two 1259C.....
127074	21827	Arm Shaft (upright) Bevel Gear (upper) with two 1259C.....
127079	22216	Arm Side Cover.....
127091	22209	Oil Tube Bracket for 127092.....
127092	22209	" " " 127091 with 127191, for oiling Feed Connecting Link.....
127095	-----	Rotating Hook with three 1253C, for 127096.....
127096	-----	Rotating Hook 127095 with 127102 and four 1053C, for 127097 and 127119.....
127097	21808	Rotating Hook 127096 with 40274 and three 1367E (For agents only).....
127098	-----	Rotating Hook 127119 with 52473.....
127099	-----	" " Bobbin Case 52473 with 127100 (For agents only).....

No.	Plate	Name
127100	21808	Rotating Hook Bobbin Case Holder with 52475 and two 52476, for 127099 and 127119.....
127102	21808	Rotating Hook Thread Guard for 127096..
127108	22208	Presser Bar Spring.....
*127119	-----	Rotating Hook 127096 with 40274, 127100 and three 1367E, for 127098.....
127135	22212	Needle Bar (hollow) with 857H, for 127137.....
127136	22212	Needle Bar Thread Guide for 127137.....
127137	-----	" " 127135 with 127136.....
127152	22207	Feed and Feed Lifting Eccentric Sleeve for 127226.....
127156	22209	Feed Lifting Rock Shaft Connecting Rod with two 966E.....
127187	21801	Arm Oil Tube (bent) with 42367, for oiling 127152, for 127193 and 15046C..
127191	22209	Oil Tube with 52184, for 127092.....
127192	22207	Arm Top Cover for 127193.....
127193	22207	Arm Top Cover 127192 with 52183, 52239 and 127187.....
*127216	-----	Arm with 15404 and two each 15405 and 56015.....
127223	22207	Needle Bar Crank (eccentric) with 1036C 1037C and 1065C, for 127227.....
127224	22207	Feed and Feed Lifting Eccentric with 446C, 52210 and 52211, for 127226..
127226	-----	Feed and Feed Lifting Eccentric 127224 with 127152.....
127227	-----	Arm Shaft (horizontal) 127024 with 52196, 127032 and 127223.....
150203	20335	Thread Unwinder Spool Rest Cushion (felt) for 225258.....
150459	21834	Bobbin Winder Tension Bracket with 460C for 150460.....
150460	-----	Bobbin Winder Tension Bracket complete for 150461, Nos. 41593 to 41595, 52183, 52239, 127187, 150459 and two 2455.....
150461	-----	Bobbin Winder (swinging automatic, left hand) complete, Nos. 41915 and 150460.....
200056E	3471	Bobbin Winder Stop Latch Screw for 225382.....
200082D	3471	Bobbin Winder Tension Bracket Screw for 225382.....
200299H	3471	Bobbin Winder Stop Latch Trip Lever Hinge Screw for 225382.....

No.	Plate	Name
200380C	3471	Bobbin Winder Pulley Set Screw for 202473.....
200383C	7729	Thread Unwinder Spool Rest Rod Set Screw for 202490.....
201018C	7729	Thread Unwinder Spool Rest Set Screw for 225257.....
201499B	3471	Bobbin Winder Tension Stud for 225461..
201572B	3471	" " " " Thumb Nut for 225462.....
201696J	7729	Thread Unwinder Thread Guide Lock Nut for 225258.....
202277	3471	Bobbin Winder Frame Oil Packing Wick for 225453.....
202407	3471	Bobbin Winder Tension Spring for 225462
202473	22204	" " Pulley with 200380C, for 225382.....
202478	3471	Bobbin Winder Stop Latch Trip Lever for 225382.....
202490	20335	Thread Unwinder Spool Stand with 200383C, for 225258.....
225257	20335	Thread Unwinder Spool Rest with 201018C for 225258.....
225258	20335	Thread Unwinder complete for two spools or two large cones of thread, Nos. 201696J, 202490, 225257, 225324, 225326, 225388, two each 150203, 225391 and three wood screws 7/8 in. No. 12.....
225322	7729	Thread Unwinder Thread Guide Rod Washer for 225324.....
225324	20335	Thread Unwinder Thread Guide Rod with 208E and 225322, for 225258.....
225326	20335	Thread Unwinder Thread Guide Position Cup for 225258.....
225381	22204	Bobbin Winder Spindle for 225382.....
225382	22205	Bobbin Winder (swinging automatic, right hand) complete, Nos. 200056E, 200082D, 200299H, 202473, 202478, 225381, 225433, 225444, 225453 to 225456, 225458, 225462, 228026 and two each 225459 and wood screws 3/4 in. No. 12 R.H.B.....
225388	20335	Thread Unwinder Spool Rest Rod for 225258.....
225390	22204	Thread Unwinder Thread Cone Holder, for inverted cones, for 225258.....
225391	20335	Thread Unwinder Thread Guide for 225258
225433	22205	Bobbin Winder and Tension Bracket Base for 225382.....

No.	Plate	Name
225438	3471	Bobbin Winder Frame Oil Well Cap for 225453.....
225444	3471	Bobbin Winder Stop Latch for 225382....
225453	22204	" " Frame with 202277 and 225438, for 225382.....
225454	3471	Bobbin Winder Frame Hinge Pin for 225382.....
225455	3471	Bobbin Winder Frame Spring for 225382..
225456	3471	" " " " Plunger for 225382.....
225458	3471	Bobbin Winder Stop Latch Thumb Lever for 225382.....
225459	3471	Bobbin Winder Stop Latch Thumb Lever Hinge Stud for 225382.....
225461	3471	Bobbin Winder Tension Bracket with 201499B, for 225462.....
225462	----	Bobbin Winder Tension Bracket complete for 225382, Nos. 201572B, 202407, 225461 and two 2102.....
228026	----	Bobbin Winder Tension Bracket Screw Washer for 225382.....

Genuine Singer Needles should be used in Singer Machines. These Needles and their Containers are marked with the Company's Trade Mark "SIMANCO." 1

Needles in Containers marked "For Singer Machines" are not Singer made needles. 2

PLATE 819—ONE-FOURTH SIZE

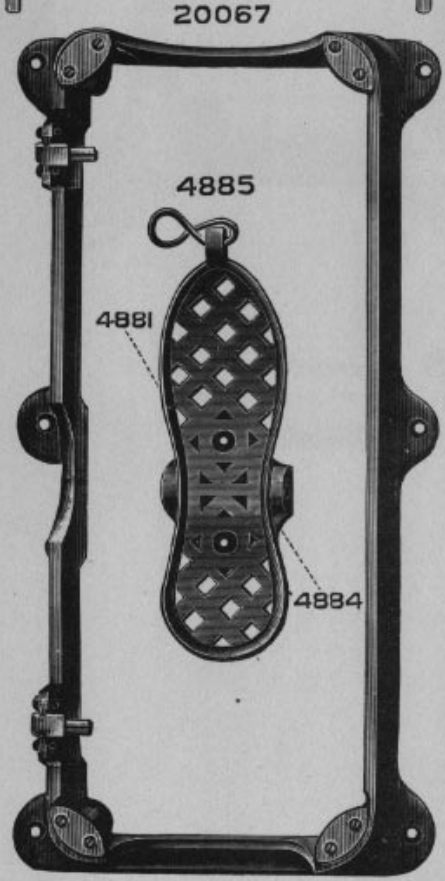
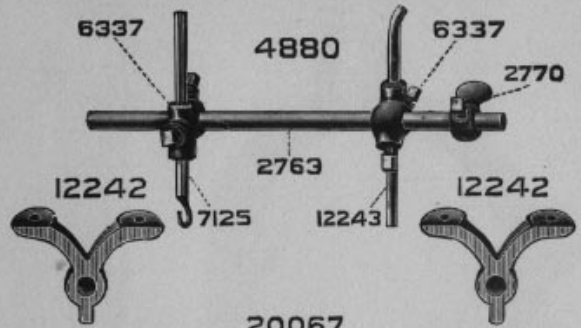

Genuine Singer Needles should be used
in Singer Machines.
These Needles and their Containers
are marked with the
Company's Trade Mark "SIMANCO." 1

Needles in Containers marked
"For Singer Machines"
are not Singer made needles. 2

PLATE 1104—ONE-HALF SIZE

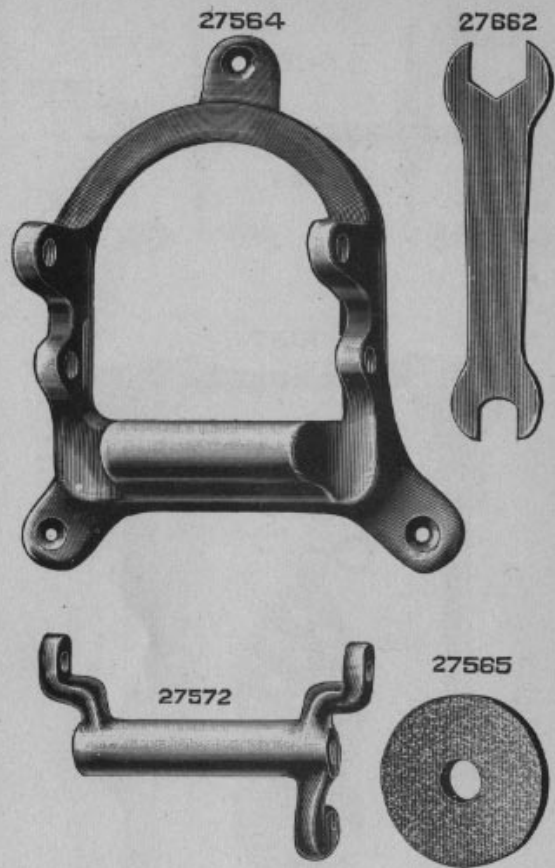

PLATE 2833—ONE-HALF SIZE

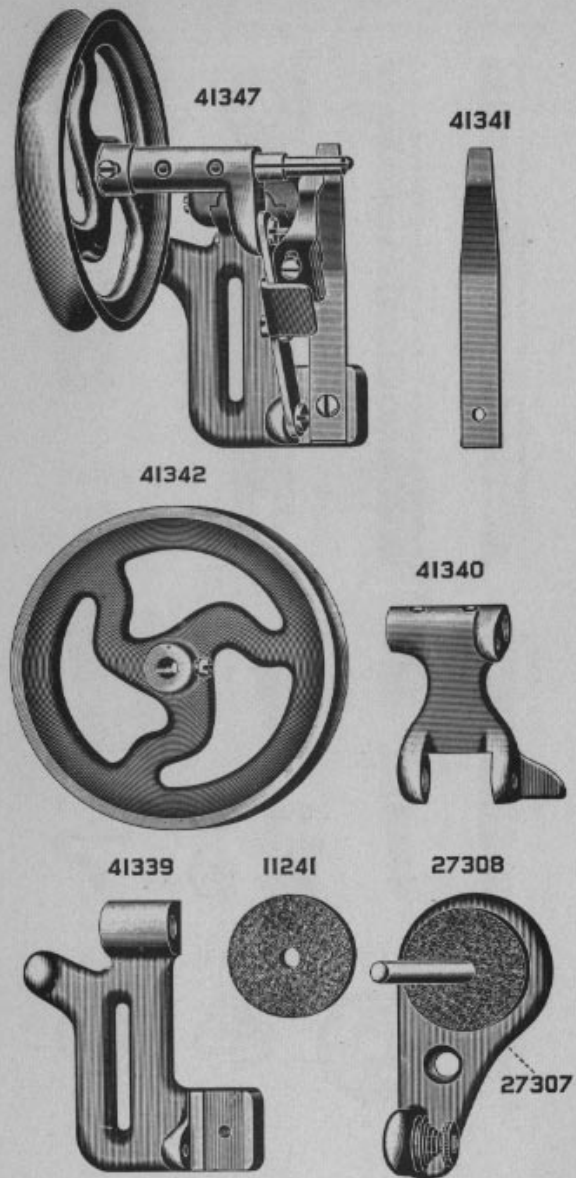

PLATE 2834—FULL SIZE

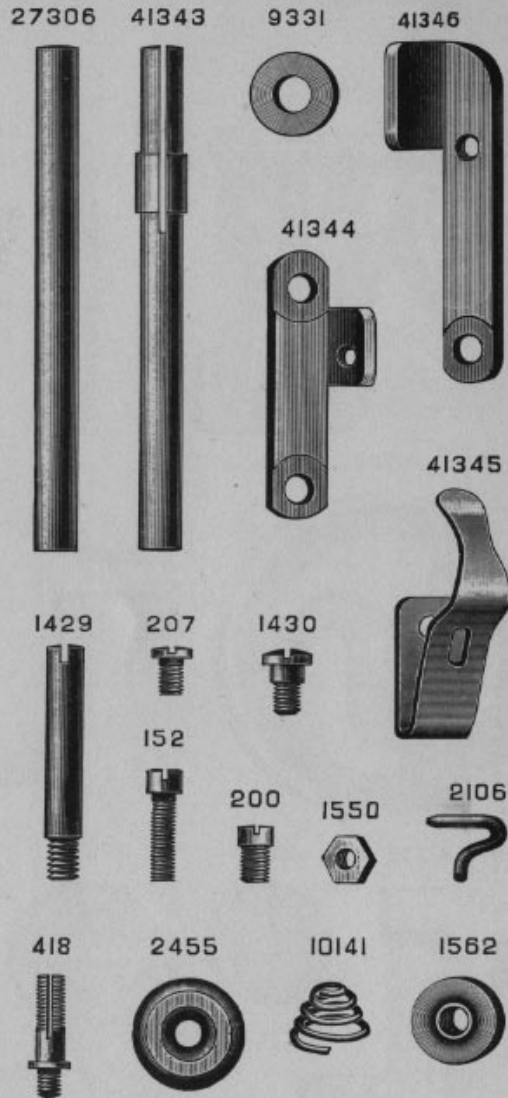

PLATE 3471—FULL SIZE

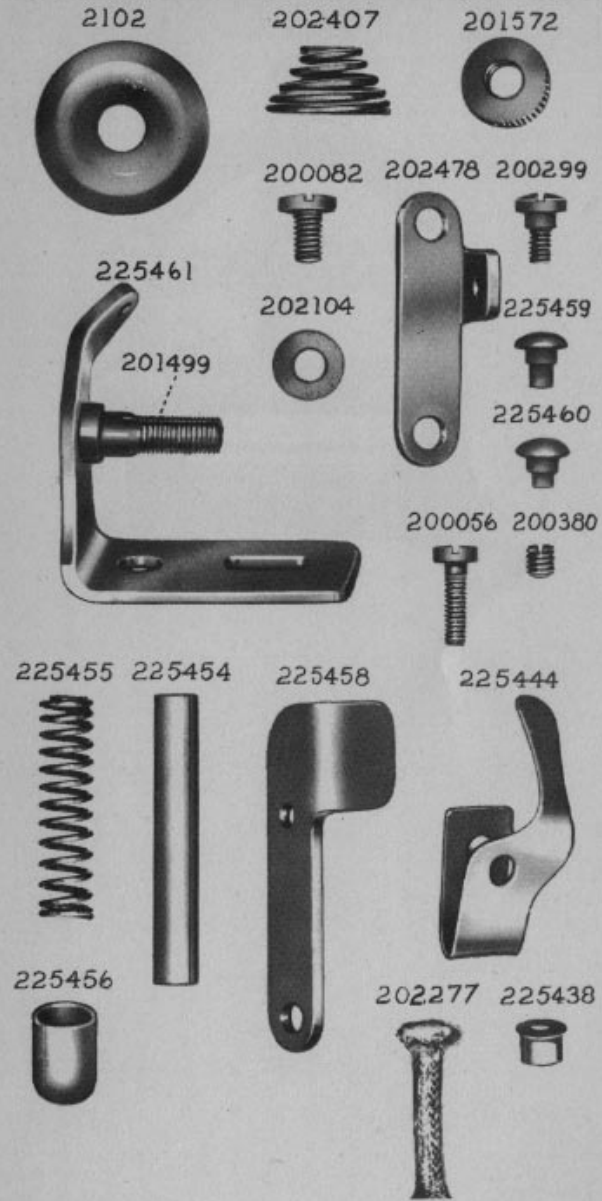

PLATE 5918—ONE-HALF SIZE

60583

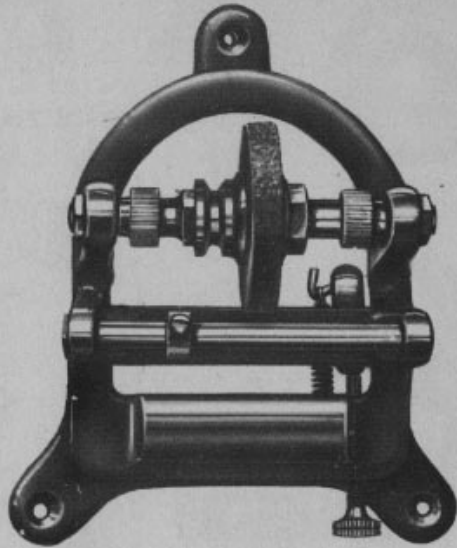

PLATE 5936—FULL SIZE

52338



12329



12398



43944

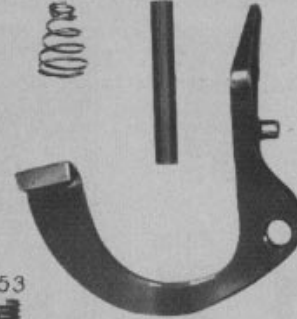

453



12327



41593



41594



41595



223



52337



52016



689



11170



12240



1520



12241



12416



8879

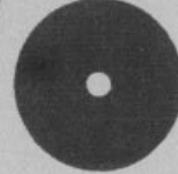

PLATE 7715—FULL SIZE

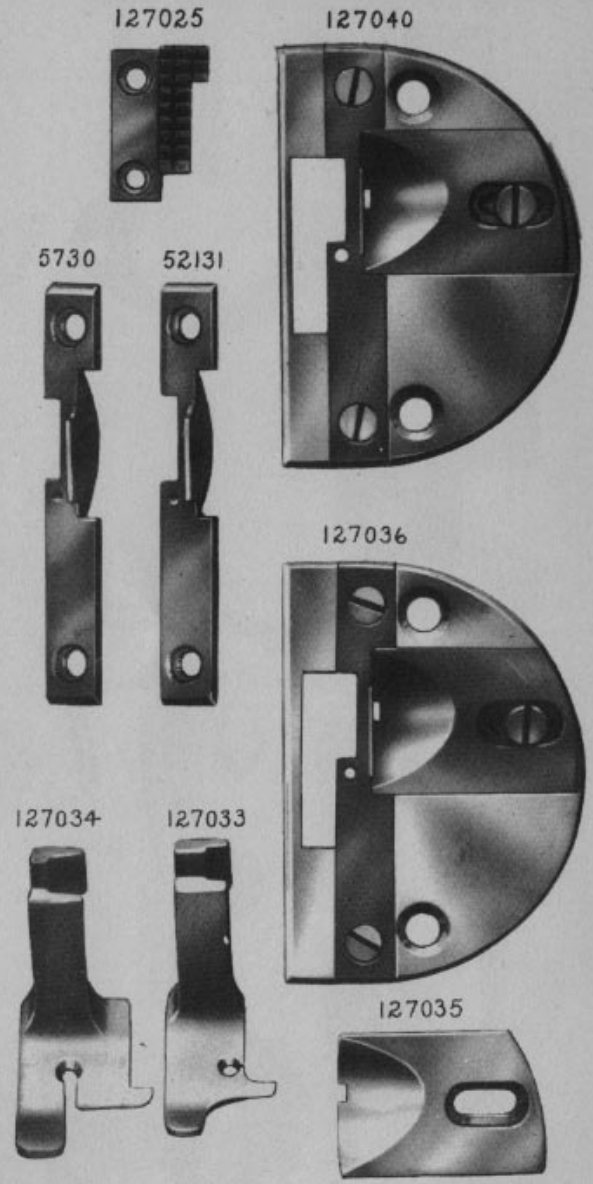
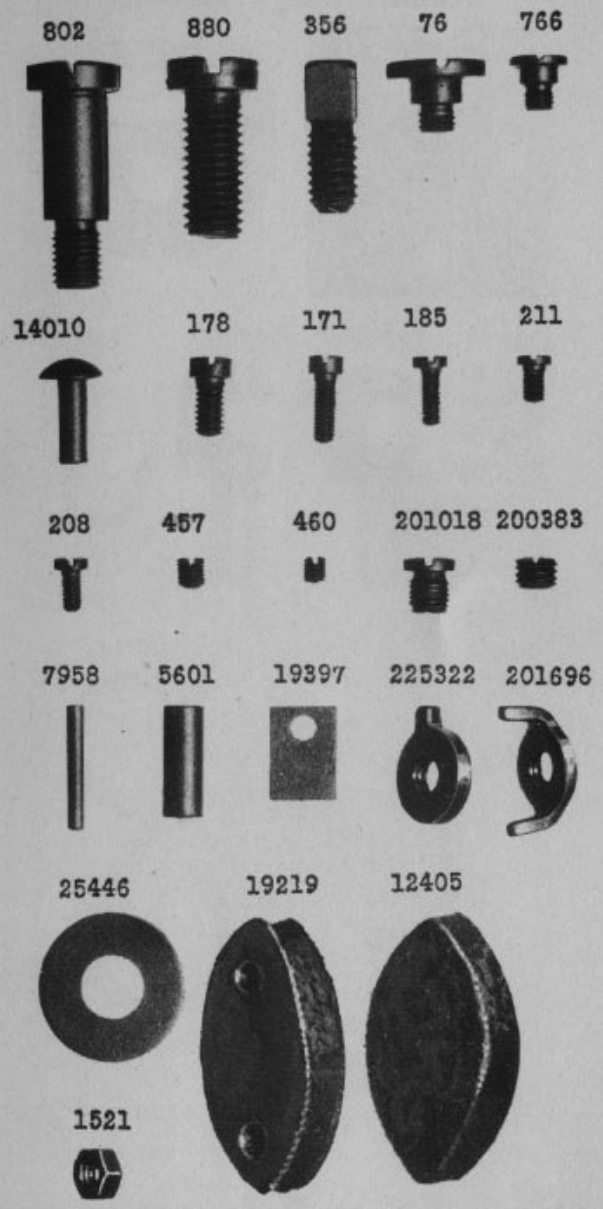

PLATE 7729—FULL SIZE



From the library of: Diamond Needle Corp

PLATE 7730—FULL SIZE

16555



44139



19220



12361



19226



56865

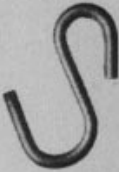

56864



4879



5735

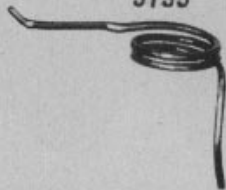
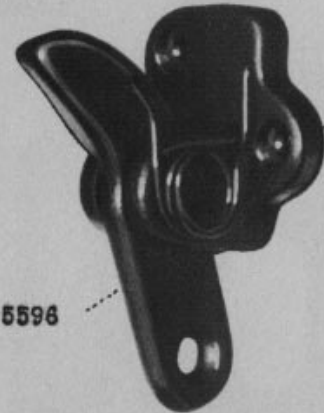

PLATE 7732—FULL SIZE

5598



5599

5596

52202



PLATE 7734—ONE-FOURTH SIZE

44212

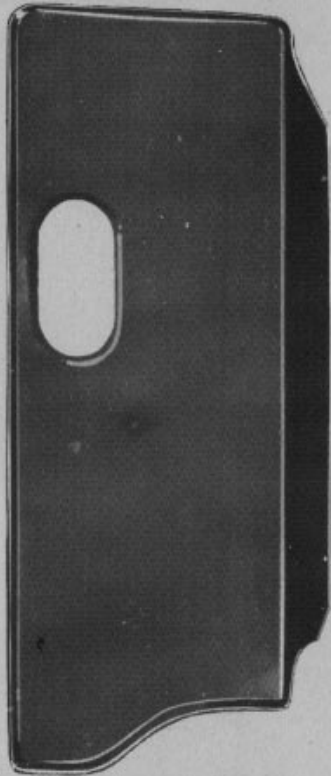

PLATE 20335—ONE-SIXTH SIZE

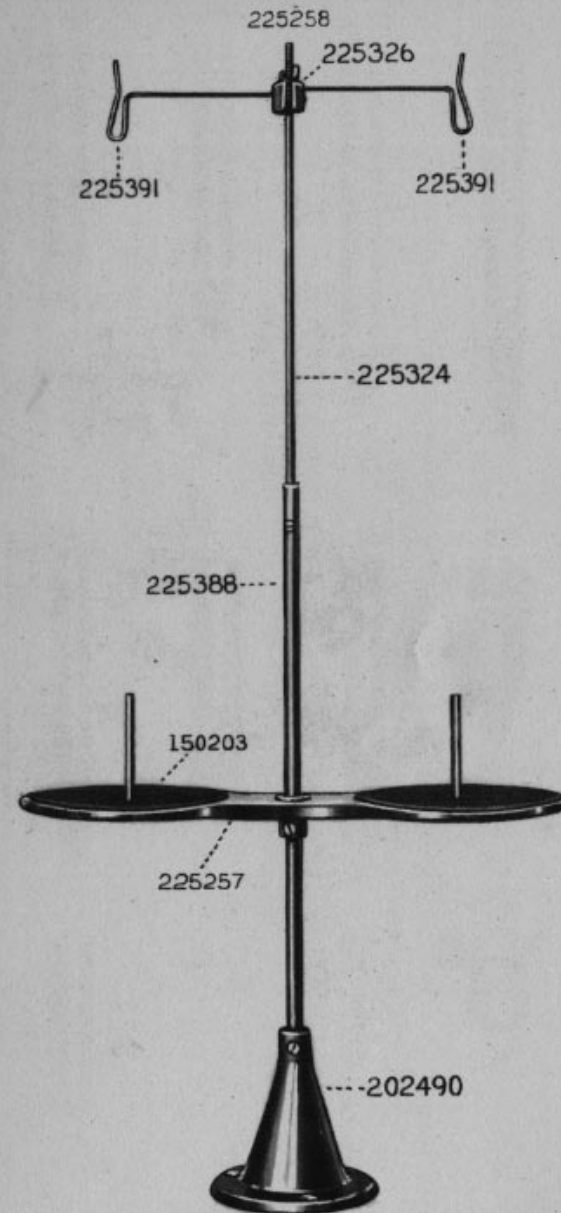
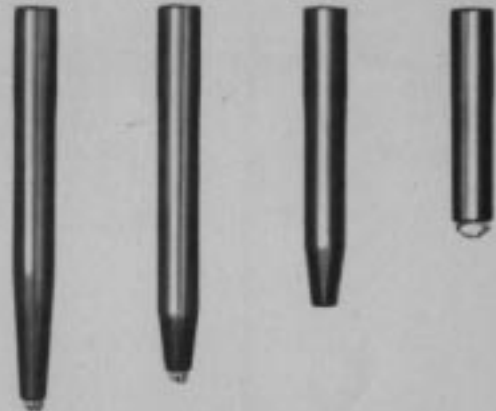
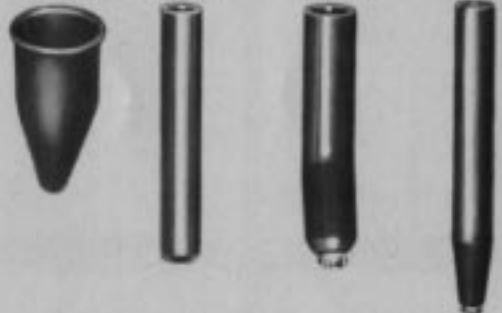

PLATE 21801—FULL SIZE

52180 52182 52183 52185



52148 56015 127187 52186



68350 42367 52150 16532

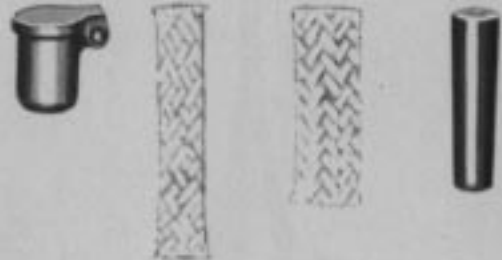

PLATE 21808—FULL SIZE

127097 127100



52473 40264 40274



40392 2975 125320 127102



40394



52018



591 592 1380 2974 1367

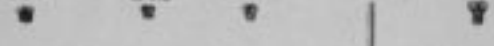

PLATE 21809—FULL SIZE

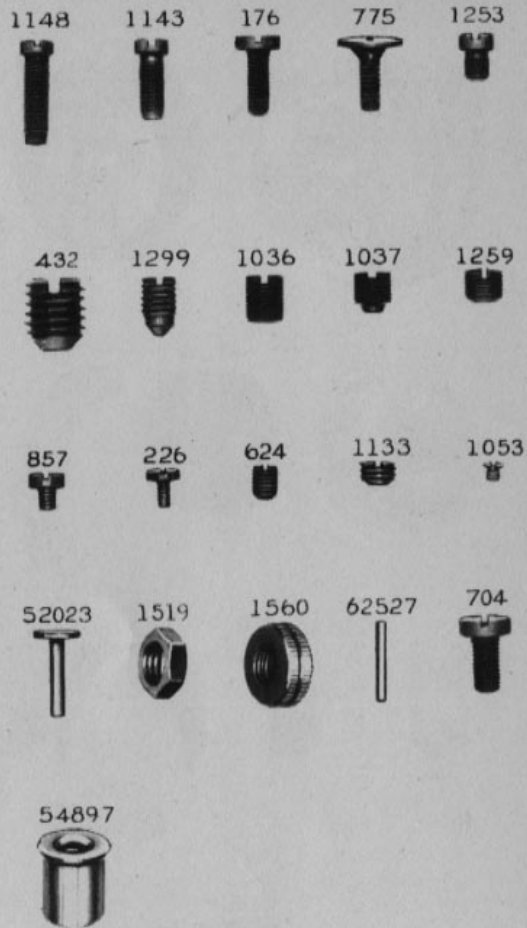

PLATE 21827—FULL SIZE



PLATE 21834—ONE-HALF SIZE

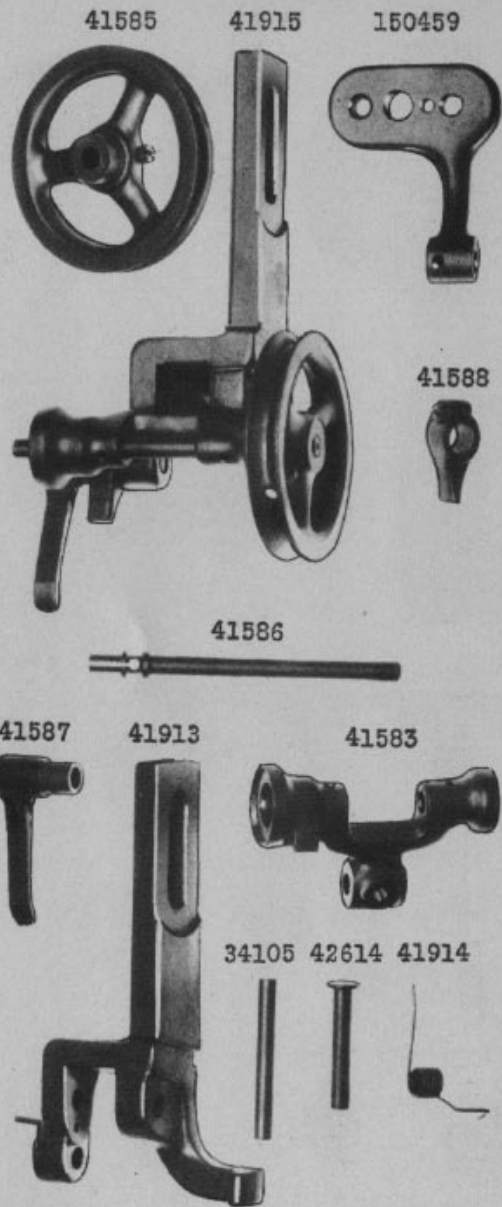

PLATE 21835—ONE-HALF SIZE

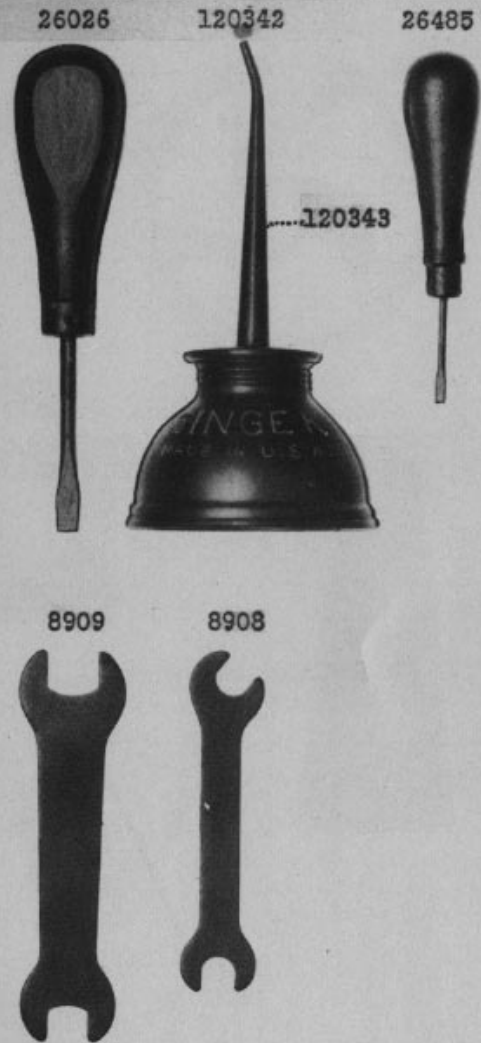

PLATE 22204-ONE-HALF SIZE

202473



225381



27739



225453



225390

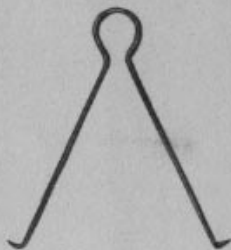

PLATE 22205-ONE-FOURTH SIZE

7539



7539



12250

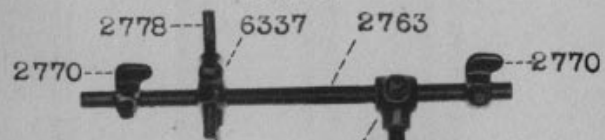

2766 2765

225382

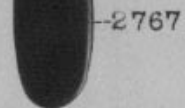

225433

PLATE 22206-ONE-HALF SIZE

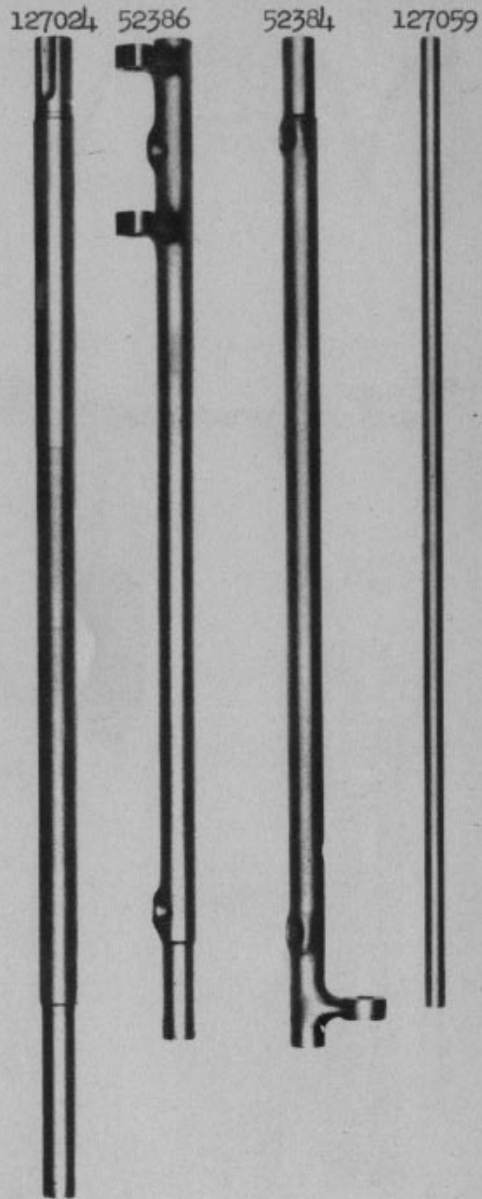

PLATE 22207-ONE-HALF SIZE

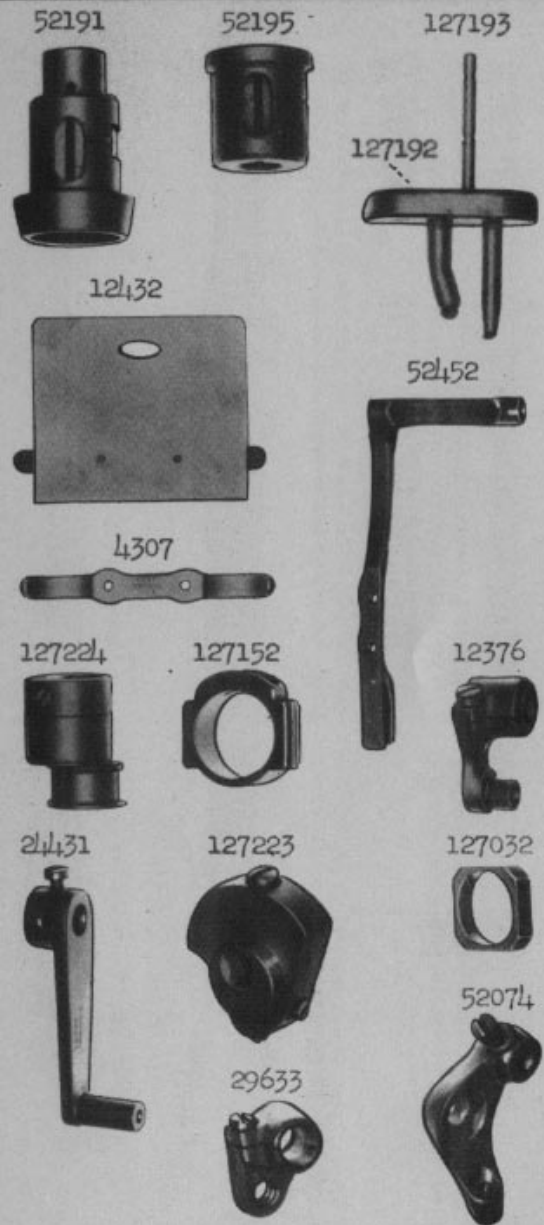

PLATE 22208-ONE-HALF SIZE

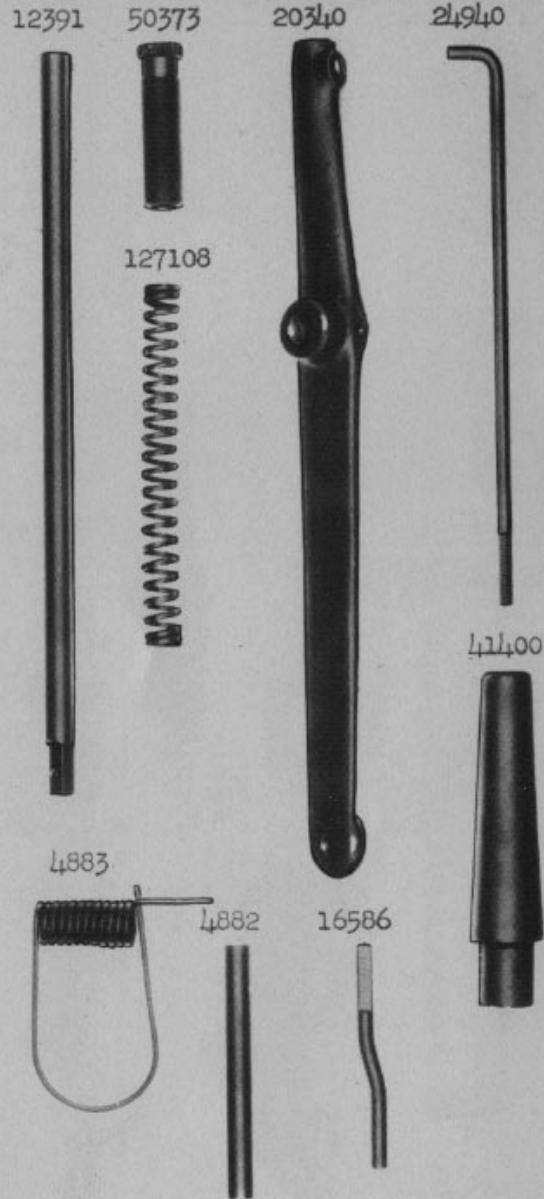

PLATE 22209-ONE-HALF SIZE

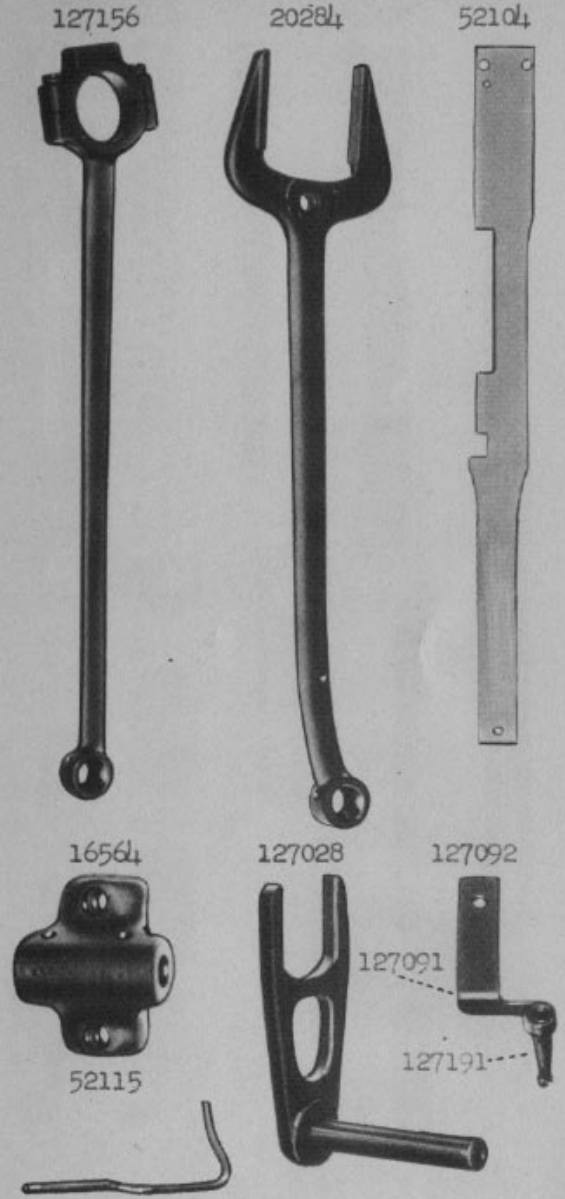

PLATE 22210-FULL SIZE

127058 52184 52193 24122 127026

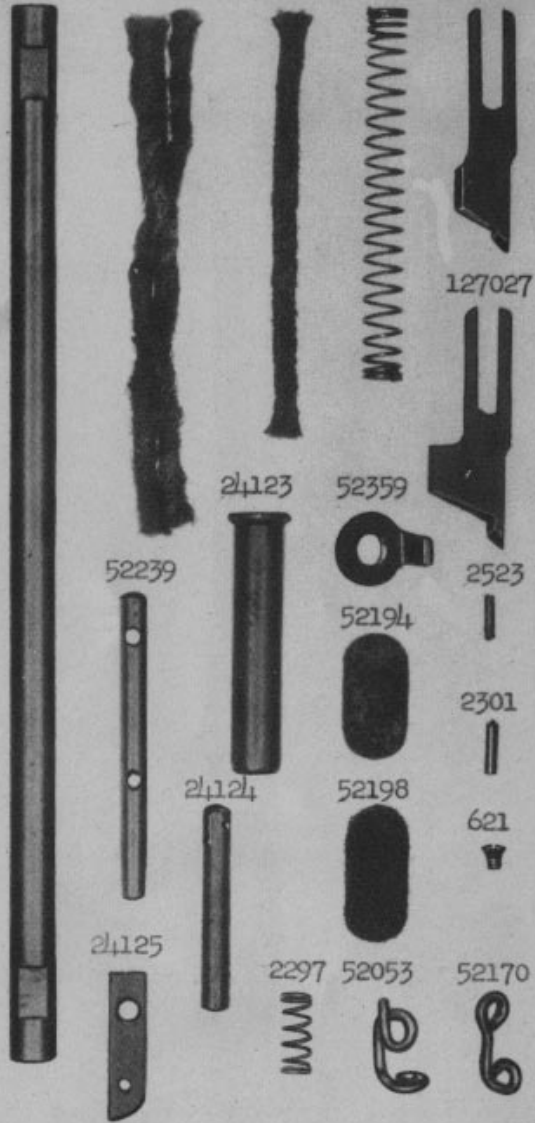

PLATE 22211-FULL SIZE

2102 32572 2103

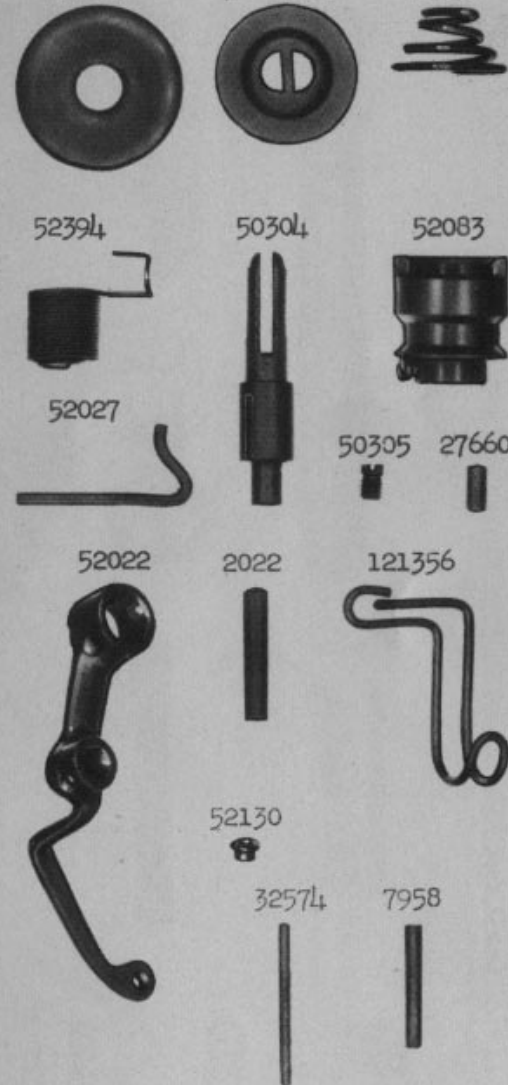

PLATE 22212-FULL SIZE

127135



52111



52108

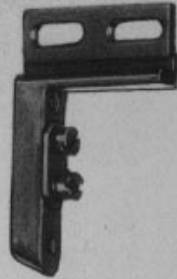

24109



52045



52200



127136



2291



52207



PLATE 22213-FULL SIZE

854

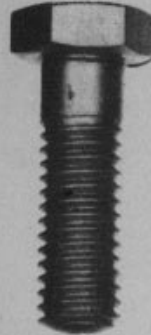

116



1128



647



818



1162



1065



435



191



691



50234



210



171



185



446



448



1564



578



457



620



PLATE 22214-FULL SIZE

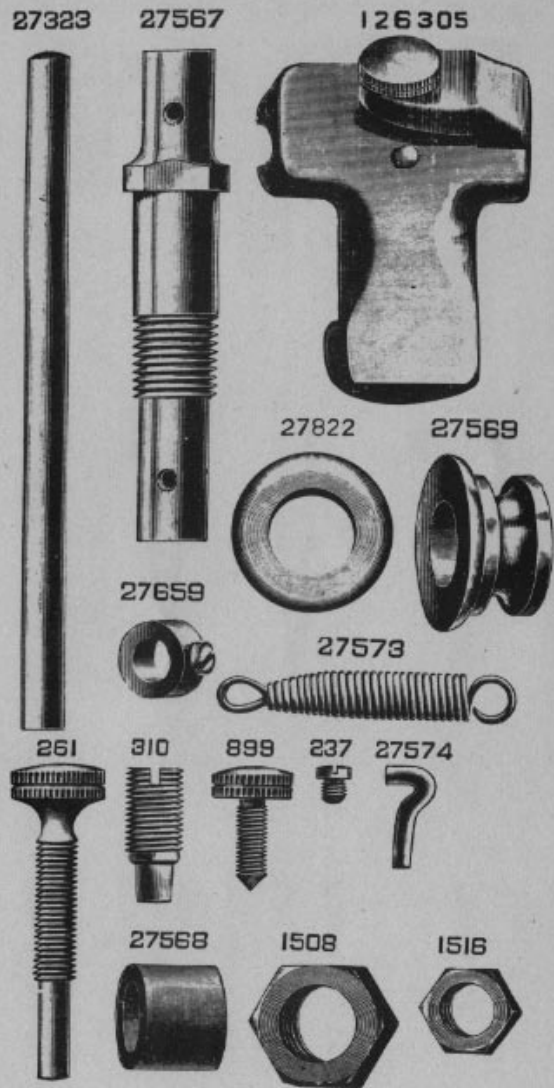
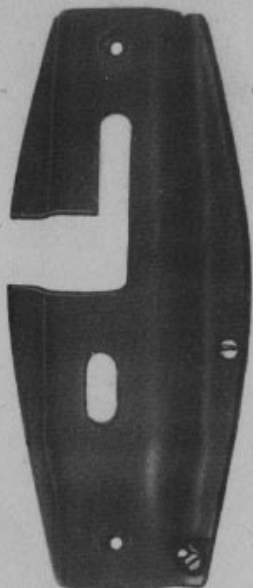

PLATE 22215-FULL SIZE

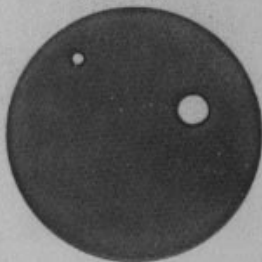

PLATE 22216-ONE HALF SIZE

52103



127079



127070



52187



127007



52063

